

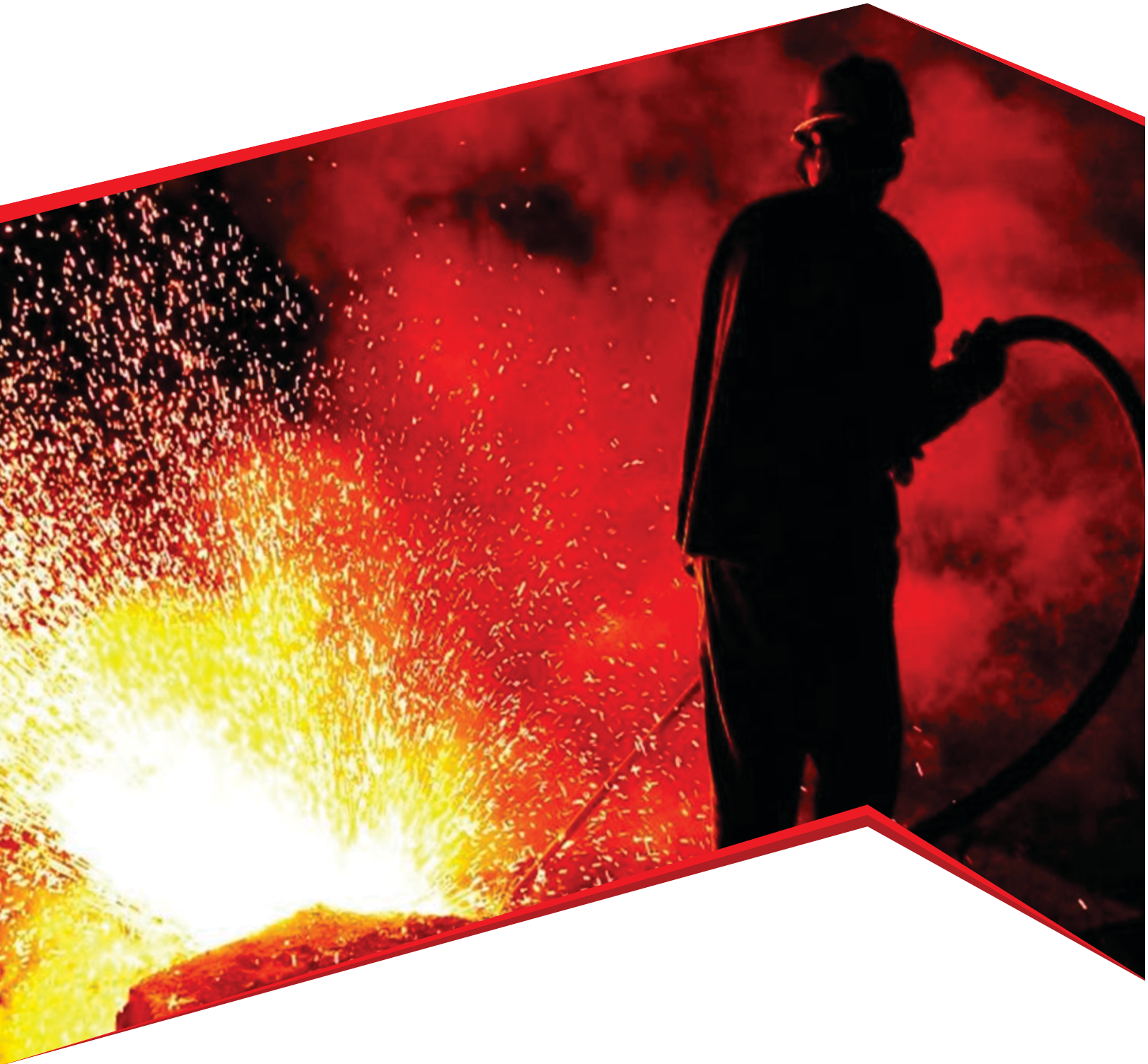

AN ISO 9001 : 2015 Certified Company



Equipping Steel Industry
at all Levels

INDEX

Range	:	Page No.
Electronics Spares	:	1-4
Crucible Spares	:	5-16
Insulation Spares	:	17-24
Lamination Yoke	:	25-30
Reactor Choke	:	31-32
Hydraulic Spare	:	33-34
Temperature Instrument & Calibration	:	35
Electrical Product	:	36
Lining Vibrator	:	37-42
Sintering Pre-heater	:	43-44
DM Water Circulation System	:	45
Sub-Station Equipment	:	46
Crane Spares	:	47-62
Continuous Casting Machine Spares	:	63-73
Ladle Slide Gate System	:	65-66

EQUIPPING STEEL INDUSTRY AT ALL LEVELS

Lawatherm Furnace Pvt. Ltd. is a multi-product and services organization that contributes to steel power sector in many ways. The company deals in manufacturing, supplying, erection, testing and commissioning the turnkey projects with discretion and credibility. Lawatherm is upcoming steel melting & material handling (EOT crane) spares manufacturing industry in operation since 2 decades. Basic idea behind the conception of Lawatherm was to transform years of knowledge and expertise into superior quality products catering to steel industry.

Based in Delhi, the company is headed by multi talented people who have years of experience in the business of steel engineered products. Be it sourcing the best vendors, investing in superior preservatives or having the best R&D facility in-house, or to constantly improve and develop products, Lawatherm, continuously makes efforts to explore, learn and initiate latest technologies for developing cost reduction, quality improvement, quick process implementations, stringent process controls and efficient product line to cater Indian and Overseas customers.

At all levels of production, we are driven by high quality products. Lawatherm has all in-house facilities for making quality compliance with the international standards of QMS ISO 9001:2008. Our each and every endeavor confirms quality standards, resulting in products of exceptional durability and strength making them tougher than conventional products.

Our wide range of induction furnace spare to the steel power requirements of 100 kw to 10000 K.W equivalent to international quality standards. We also offer a comprehensive range of products like Electrotherm, Megatherm, Inductotherm, GA Denali (GEC), Pillar, Superheat, Indotherm that satisfy various requirements of our clients. Our range of products includes different types of Induction Melting, Holding, Hardening, Heat Treating, Ladle Refining, Electric Arc Furnace, Blast Furnace, Ferro Alloys , Continuous Casting Machine , Tube Mill & HF Welder Spare.

Lawatherm is a division of The Lawa Group of Companies which has a standing in wide areas of steel, power, engineering and many more industries. The foundation of the group is based on three core values: Respect for the Individual, Service to the Customer and Excellence in the Pursuit of our Goals. And the group will continue to stay focused on its beliefs and remain committed to provide innovative next-generation products and services that will help the industry in its need for the future.

We are guided by our core beliefs to promote the well-being and development of our employees (as well as their families) through our stated corporate value of "Respect for the Individual". As our business continues to evolve, we encourage and enable all our people to develop and grow with it.

LT

LAWATHERM

VISION, MISSION & VALUES

OUR VISION

To become leading steel player manufacturer of Steel Melting & Handling (EOT crane) spares all over the world.
"We keep together and work together for success"

OUR MISSION

To continuously update and upgrade ourselves, so that we manufacture only the best quality products.

OUR CORE VALUES

- Customer is Priority
- Passion for People
- Business Excellence
- Integrity, Ownership & Sense of Belonging
- Transparent and Ethical Working
- Team Work

"Success is not what you achieve compared to others.
It is what you achieve compared to what you are capable of."





OUR STRENGTH

The Lawa Group has changed significantly in recent years and continues to evolve keeping in pace with the changing times. We have undertaken a sustainable journey of transformation by foraying into new international markets and exploring new business areas in a bid to keep our entrepreneurial spirit alive, and to continue growing. The real strength of Lawatherm lies in:

- All processes in house
- Machinery and equipments as per latest technology
- All testing facility in house
- A highly experienced and knowledgeable working team
- Precision with zero defect
- Superior finish
- Customer satisfaction
- Quality assurance
- Timely dispatch

MANUFACTURING FACILITIES

We started as a steel manufacturing company, and diversified into various other sectors such as Melting, Handling, Consultancy and Education. Lawa Group operates 3 manufacturing units across Delhi States in Northern India. Our Unit-1 is located in Punjab Khore Village of Outer Delhi District. This unit was established in 1989 and is well-equipped with a unique facility of producing induction furnace spare & insulation. Unit-II and Unit -III on the other hand are located in Bawana Village of Outer Delhi District and were established in 1994 and 2007 respectively. Both the units are equipped with unique facility of producing steel melting products and Handling Spare (EOT CRANES).

Our Manufacturing team uses the latest manufacturing process to produce reliable products with the help of fully equipped and latest mechanics & other equipments.

Carved out of iron, we are the steel people and believe in our power.

SERVICES

We are committed to adopt such manufacturing processes which deliver zero-defect precision and facilitate complete satisfaction to our valued customers. At Lawatherm we are aimed at providing services to industries using intensive power e.g. Steel plants, Ferro Alloys, Sponge Iron, Blast Furnace, Power, Cement, Paper, Sugar, Engineering and many more industries.

NATURE OF SERVICES OFFERED

The area of services which we provide includes: Design, Consultancy, Erection, Commissioning & Project Execution for steel sector. Our specialty is in offering Single Window consultancy for Steel, Power Projects in:

- Civil
- Structural
- Mechanical
- Electrical
- Instrumentation
- Pump & Piping work
- Erection & Commissioning work

MILESTONE

Lawatherm has installed more than 500 steel plants all over India & supplying its spares to all major steel industries.

ERECTION & COMMISSIONING SERVICE

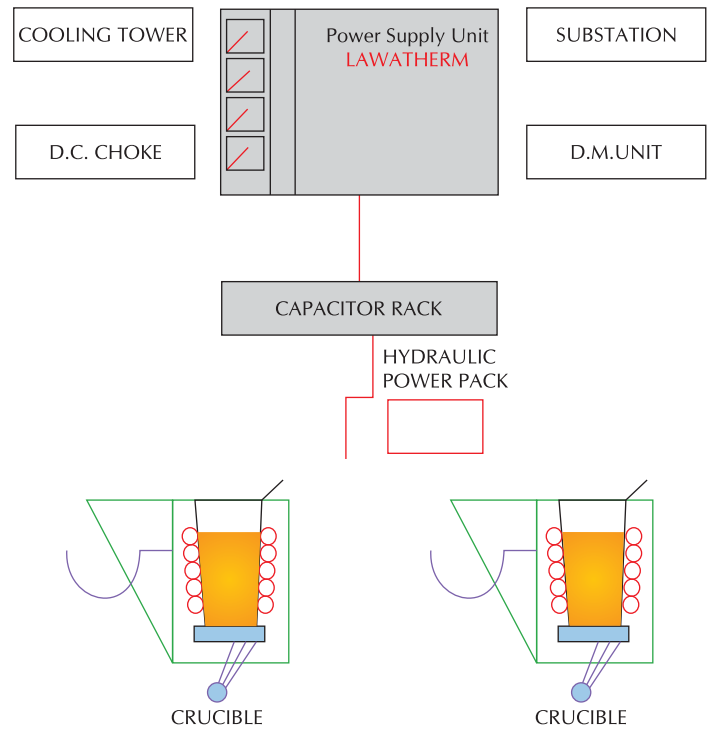



SOLID STATE GENERATOR PANEL

Lawatherm is a leading edge distributor of power electronic components like MF water cooled capacitor, SCR thyristors, Diodes, IGBT's power module, semiconductor & HRC Fuse, Sunubber Capacitor & Resistor, Temperature sensor / switch / gauge / thermostat along with other passive components like analog / digital meter, connectors, LED and relays. A highly experienced team of engineers equipped with required infrastructure are always available to offer expert advice and services on a vast range of products and topics. Lawatherm holds in-depth stocks of a wide range of products including some of the best brands i.e. IXYS Westcode, ABB, Eupec, Proton, Copper Bussmann, Ferraz-shamut, Gold, Yaco, RARA, Arcol-UK, Kiyosh, Semikron, Hirect, Ruttonsha, and various other National & International companies and provide our clients the opportunity to single source their requirements. We are here to help! Our sales team is dedicated to customer service and offers technical advice to ensure the correct selection of product. We pride ourselves on our responsive and flexible approach to meeting our clients' various needs and endeavour to maintain a close working relationship with those customers.



MF WATER COOLED CAPACITOR

MF water cooled capacitors are designed for very high levels of safety, reliability and life expectancy. Capacitors are provided with high thermal conductivity copper tubes, through which cooling water is circulated. The effective dissipation of heat by this method is extremely important to achieve desired performance and life expectancy levels. The water-cooled capacitors are generally enclosed in aluminum cases so as to avoid heating due to magnetic fields. Thus the capacitors run much cooler compared to those of conventional design. Their expected life is also longer. In the dead case construction the current returns through water-cooling terminals instead of through the capacitor case. This leads to longer capacitor life since less heat is generated in the case and absorbed by dielectric fluid. This construction permits, capacitor mounting directly to the chassis without insulators, permitting savings in installation expenses.



SEMICONDUCTOR & HRC FUSE

Semiconductor & HRC fuses are used to protect against over-current conditions in Semiconductor devices. Because of their fast action, semiconductor fuses help to limit short circuit current significantly. Our products portfolio includes some of the best brands i.e. Copper Bussmann, Ferraz-Shawmut, Gold, Yaco, Simens, GE, and various other National & International companies and provide our clients the opportunity to single source their requirements.



SCR INVERTER & CONVERTER THYRISTOR

Thyristors are "normally-off" switches that can be triggered "on" by a small current pulse into the gate electrode. Once turned on (or "triggered"), the component then stays in the conducting state even when the gate on-signal is removed. It only returns to the "off" (blocking) state if the current falls below a certain minimum or if the direction of the current is reversed. Some sources define silicon controlled rectifiers and thyristors as synonymous. Our products portfolio includes some of the best brands i.e. ABB, IXYS-Westcode, Epuec Proton-Electrotex, Semikron, Hirect, and various other National & International companies and provide our clients the opportunity to single source their requirements.



IGBT POWER MODULE

Module turns on by applying a pulse current to a gate current. However, because it is a latch type semiconductor, the thyristor only turns on when a sustained current (holding current) reaches a set level. To turn off in a DC circuit, the gate current must be reduced below the holding current or reverse voltage has to be applied using a commutation circuit. In an AC circuit, the pulse current has to be applied to the gate current whenever it is positive, because the gate current falls below the holding current and the thyristor turns off whenever the current alternates.

Our products portfolio includes some of the best brands i.e. ABB, IXYS-Westcode, Epuec Proton-Electrotex, Semikron Hirect, Ruttonsha and various other National & International companies and provide our clients the opportunity to single source their requirements.



SNUBBER CAPACITOR

Snubbers are any of several simple energy absorbing circuits used to eliminate voltage spikes caused by circuit inductance when a switch— either mechanical or semi-conductor—opens. The object of the snubber is to eliminate the voltage transient and ringing that occurs when the switch opens by providing an alternate path for the current flowing through the circuit's intrinsic leakage inductance. Snubbers in switch mode power supplies provide one or more of these three valuable functions.

Our products portfolio includes some of the best brands i.e. Arcotronics, GE Afcos and various other National & International companies and provide our clients the opportunity to single source their requirements.



WCR HIGH POWER RESISTOR

Water cooled resistor having been originally designed for thyristor protection circuit. Where water cooling is available and space limited. The withdrawal of heat, internally & externally ensure a low temperature gradient across the unit reducing internal stress. Heat is extracted internally through the cooling pipe & externally by direct mounting on to chassis or additional water cooled heat sink thereby reducing temperature gradient across internal insulation.

Our products portfolio includes some of the best brands i.e. Arcol, RARA, Kiyosh, raatronics and various other National & International companies and provide our clients the opportunity to single source their requirements.



TEMPERATURE SENSOR/GAUGE

Temp sensor convert a temperature change into mechanical displacement, are the most recognized bimetallic objects due to their name. Lawatherm has been leading manufacturers in the field of thermal regulation and protection with a wide range of plate and Disc type bimetallic thermostats. These snap-action devices, with Quick Make/ Quick Break action, automatically manual reset with Brass Round mounting stud of M4 X 0.7 mm threads at preset temperature. An electrically isolated bimetal disc is used to either open or close the circuit current. Rating: 10Amps250VAc Temperature: 40 to 190°C (At 10°C interval).

Our products portfolio includes some of the best brands i.e. Honeywell, Lawatherm, Elmwood and various other National & International companies and provide our clients the opportunity to single source their requirements.

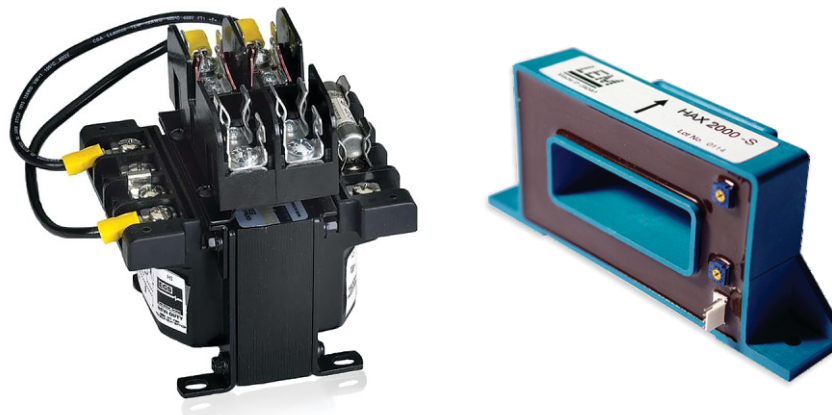

CONTROL TRANSFORMER

Transformer is a static electrical device that transfers energy by inductive coupling between its winding circuits. A varying current in the primary winding creates a varying magnetic flux in the transformer's core and thus a varying magnetic flux through the secondary winding. This varying magnetic flux induces a varying electromotive force (EMF) or voltage in the secondary winding. Lawatherm offers a complete line of Industrial Control Transformers, which provide stepped-down voltages to machine tool control devices. Each unit must pass rigid tests for turns ratio, insulation, continuity, and over potential. Performance meets or exceeds ANSI/NEMA ST-1 requirements. With a 50-60 Hz operation standard, transformers are designed for loads requiring extremely good regulation. Regulation also exceeds ANSI/NEMA requirements.



DIODE

The most common function of a diode is to allow an electric current to pass in one direction (called the diode's forward direction), while blocking current in the opposite direction (the reverse direction). Thus, the diode can be viewed as an electronic version of a check valve. This unidirectional behavior is called rectification, and is used to convert alternating current to direct current, including extraction of modulation from radio signals in radio receivers—these diodes are forms of rectifiers.

Our products portfolio includes some of the best brands i.e. ABB, IXYS-Westcode, Epuec Proton-Electrotex, Semikron, Hirect, Ruttonsha and various other National & International companies and provide our clients the opportunity to single source their requirements.

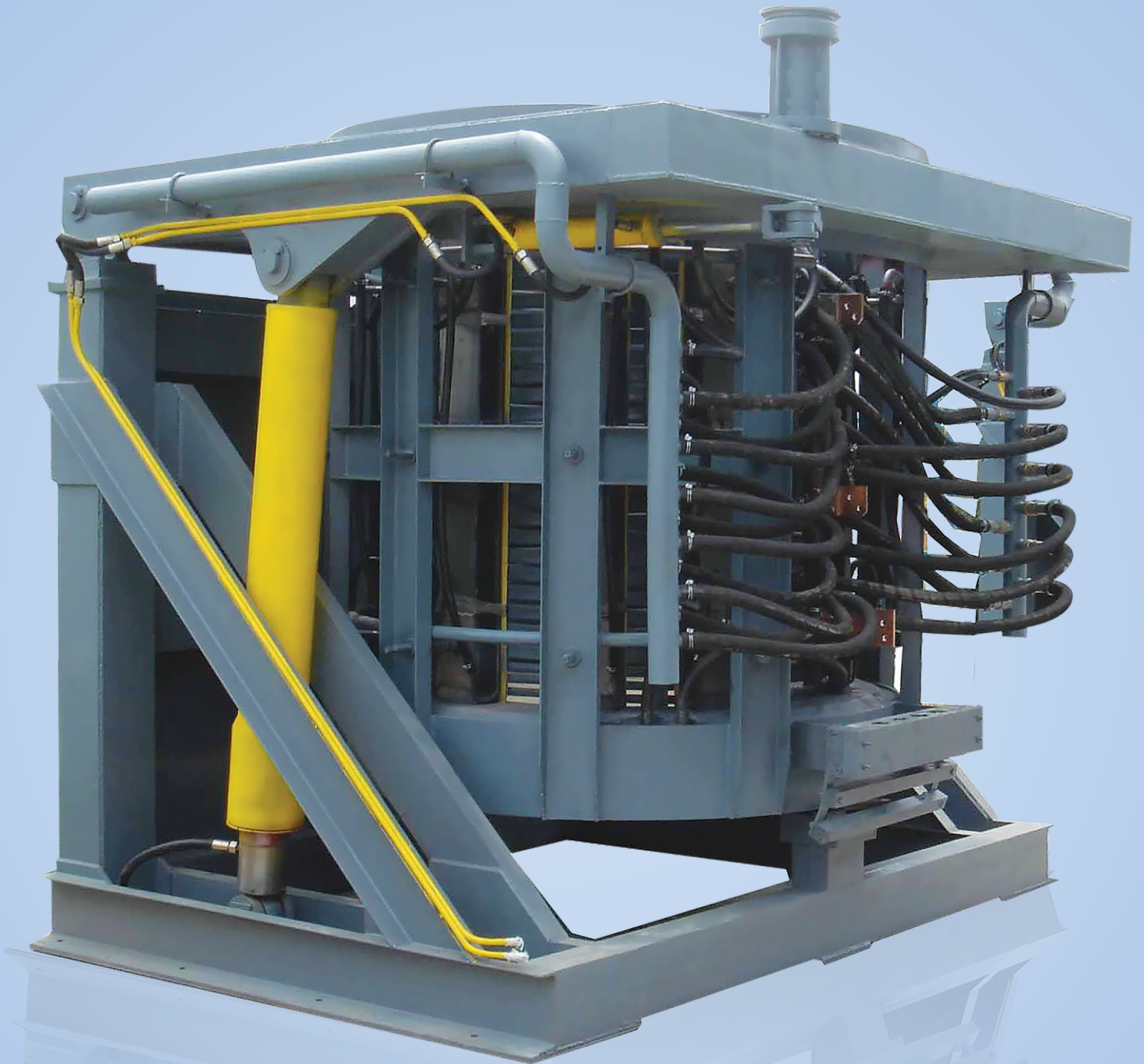

CRUCIBLE SPARES

We offer clients a wide range of precision finished crucible spares. Based on latest technology based processes, these are available in form of flow switches, change over switches, hose clamps, water cooled cables, silicon lamination cores and others. Our process expertise also allow us to deliver these in specific finishes as defined by the clients.

INDUCTION FURNACE COIL

Coil of an induction furnace is considered its main part. The main function of the coil is to create magnetic fields required to conduct eddy currents that leads to heating or melting scrap metals or processed ores. Taking into account the role and importance of this part, the electrical and mechanical properties of coil remarkably affects the function and efficiency of the furnace. Therefore, considering diversity of material and quality of parts used for manufacturing coils, Lawatherm provides a wide range of coil design for the induction furnace, whether designed in the company or as the drawings of the original coil provided by the costumers (in case an spare part is being provided). So, customer will be able to choose design, used material and even properties of the insulation on the intended basis.

A schematic view of conventional designs of coils manufactured by Lawatherm for its costumers all across the world are as follows:

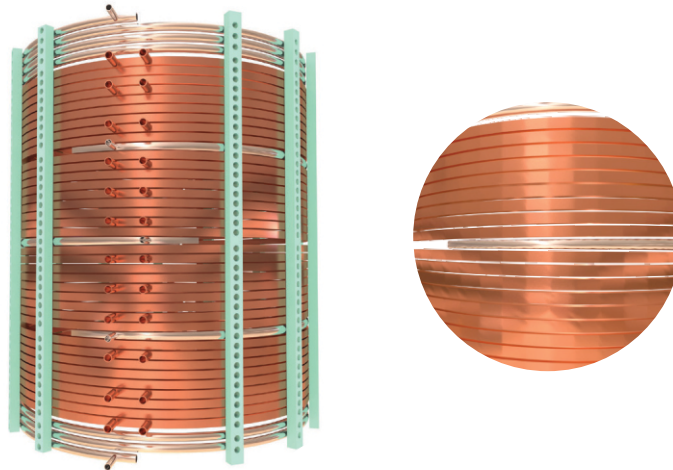

HELICAL COIL

Mostly designed using a number of contrary coils assembled to gether, Helical Coils, winded as spirals, are the most conventional ones practically. The main flaw for this design is the significant gap created between different parts of the coil including contrary active parts of the coil and neutral cooling parts. Being unable to provide smooth edges and adjust height of the coil precisely and finally im balance of magnetic field produced by the coil are the other disadvantages. Most of coils manufactured by Chinese companies and some Turkish factories are placed in this category.

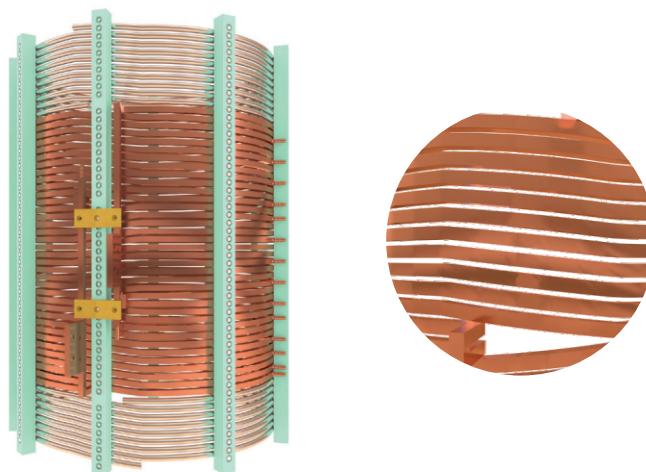

OFFSET COIL

The design of these coil are similar to the helical ones but with a small difference based on the idea of creating an offset in each 360-degree rotation of loops; so, each layer almost comes to a flat, horizontal condition except the offset area. Therefore the design doesn't have the problems mentioned for the helical coils. Taking into account the physical conditions of coil, there is no airspace between different parts of the coil; the upper and lower parts of the coil are created as flat and parallel to enable manufacturer and user to adjust height of the coil precisely. Because of the perfect balance between loops of the coil, the magnetic field produced by coil is more harmonious in different parts inside it. Most of coils manufactured by Indian companies like Electroterm and Megatherm and also some coils made by American companies like Ajax are places in this category. It is recommended using this kind of coils in high power and high capacity furnaces.

Induction Furnace Coil

DESIGN

The precise design of a coil, electrically and mechanically, using software and computer simulation is the first step of manufacturing a coil. This step is important not only for coils designed in the company, but also for ones manufactured on the basis of drawings provided by the costumers. Finally, according to the simulations and the results conducted, the necessary drawings and a list of required material is being executed and sent to the production department to begin the production.

DUAL TURNS COIL

The main feature of this design is merging the two active parts of the coil together and inside each other. Generally the two active coils lo-cated at the centre are designed as spirals (like helical coils) while the upper and lower parts that are neutral cooling coils are wound as off-set coil. Advantages of this kind of coil are high functional efficiency and more suitable water circulation. Most of coils manufactured by German Companies and some Turkish companies are placed in this category.

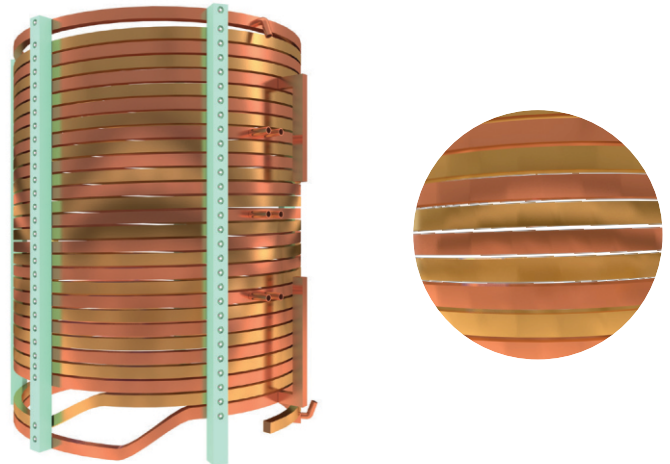

RECTANGULAR COIL

Winded in a rectangular section, a rectangular coil is mainly used in channel furnaces and sometimes in the preheating furnaces. The size of these models are generally smaller than the above-mentioned coils. This kind of coil is manufactured and used is two forms: Helical and Bended straight.

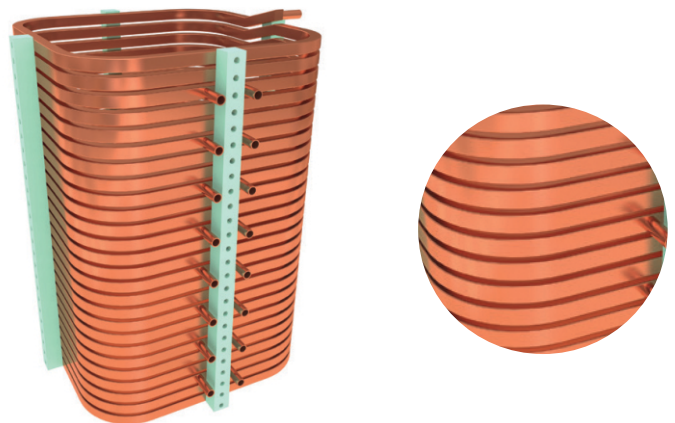

ACTIVE PART

The active part of a coil is in charge of creating magnetic field required to run the melting or heating process and is composed of layers of copper tubes. There are three very important points about the copper tubes:

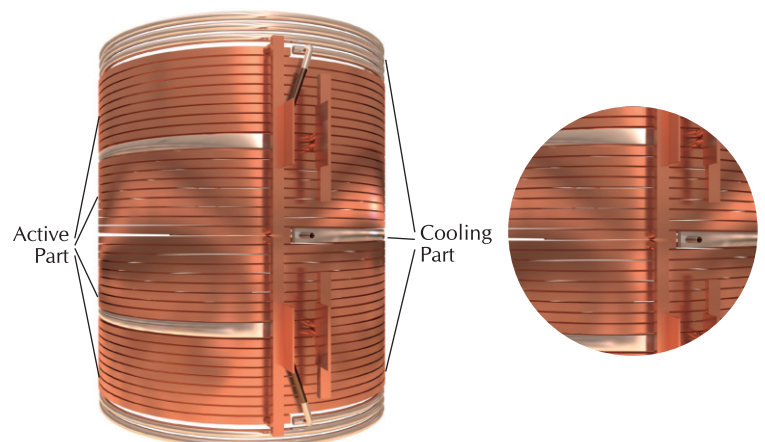

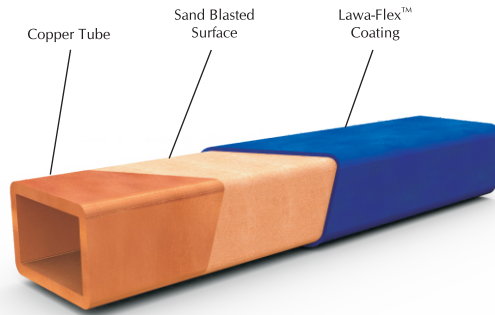

METHOD 1

Lawatherm has invented a special insulator for insulating coils made by the company, named Lawa-Flex, as its brand. The most important property of this special insulator, which is an electrostatic powder dye based on epoxy, is that it doesn't crack or separate from the coil's surface in case of intense expansion and contraction of conductors of the coil during application. High thermal endurance, high insulation strength and uniform adhesion specification while applying with a special instrument are other properties of this special insulator. This insulator is applied solely, without using other auxiliary materials; no need to use other insulators like liquid ones and insulator tapes in addition to Lawa-Flex™ in case of using the coil in standard conditions. Taking into account that it is possible for Lawatherm to apply the said insulator, the coils manufactured may be insulated using Lawa-Flex2M as Method No.1. It should be noted that coil undergoes a complete sandblast before applying the powder insulator to remove oxide layers from its surface.

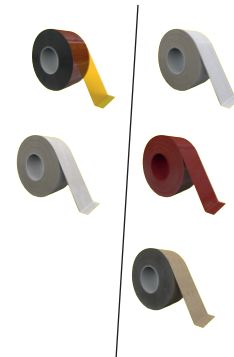
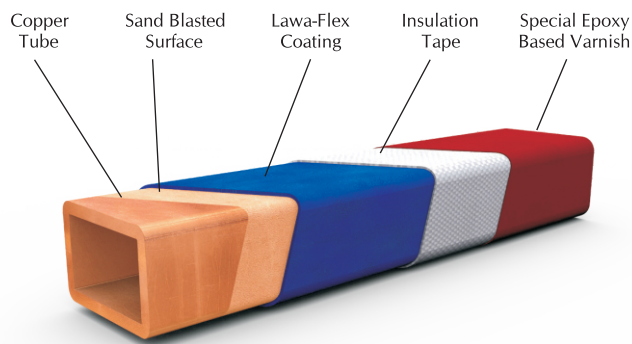

METHOD 2

In method no.2, in addition to primary insulation of coil using Lawa-Flex, a layer¹ of insulation tape and a special epoxy liquid are used to improve security margin of application. Using this method is suggested only when the coil is used in a high risk and non-standard conditions; otherwise, in case of using the coil in a proper and standard conditions, Lawa-Flex will be sufficient.

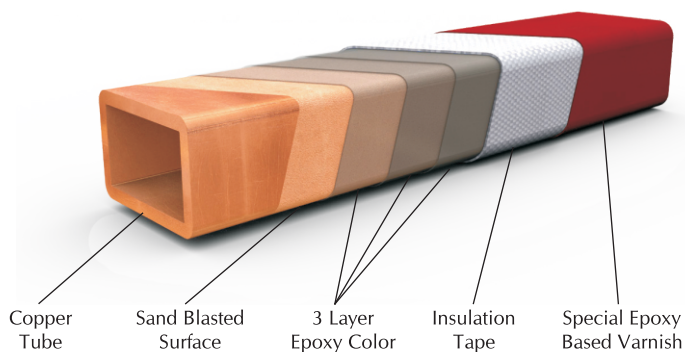

METHOD 3

Using this method, insulation is applied without Lawa-Flex. After a complete sandblast of the coil, its surface is coated using three layers of special epoxy dye; then, a layer¹ of insulation tapes are winded on it and finally, a layer of special epoxy liquid varnish is sprayed on the surface. This method is used when repaired coils are insulated and miniature leakage is probable.

Induction Furnace Coil

MATERIAL OF THE COPPER TUBES

The copper used to make sections applied in the active part of a coil should have the maximum purity (at least 99.9%) and conductivity (at least 58 mega Siemens per meter); the impure part of the material should contain the least amount of disturbing elements like Phosphorus, Oxygen and Iron that cause intense drop of conductivity, explosion and excessive heating of coil. Thus, taking into account the above-mentioned descriptions, Lawatherm uses the refined copper grade ETP-C11000 and sometimes OFC-C10100 for specific orders, to fulfil all the required conditions.

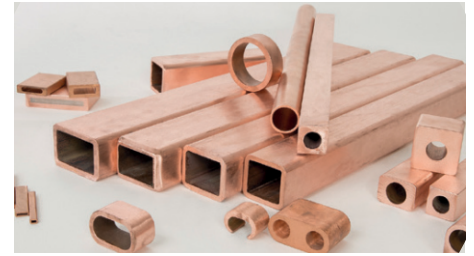

HOLDER BOLTS

Function of holders is connecting support to the body of the coil and include Stainless steel bolts grade 304 or 316, welded to the surface of copper tubes (with or without copper intermediates) or brass bolts which are restrained by flat washer, spring washer and nuts.



INSULATION

Coils manufactured by Lawatherm are always insulated observing all the details; all the points are insulated from each other in a multi-layer way. Since coil insulation prevents coil breakdown and continual stoppage of melting, technical experts of Lawatherm consider this matter during stages of coil manufacturing. Thus, Lawatherm suggests three methods depending on the customer's requirement.

SHAPE OF SECTIONS

Amongst many properties Shape and cross section of copper tubes affects the coils productivity and long-life the most. In addition to this fact that the effective area of the section must be enough to carry the enormous current conducted through the coil, geometric shape of the section is very important and is not generally considered as it deserves. Geometric shape of the section should provide enough space for current flow of the coil considering two points: Firstly, depth of magnetic field penetration inside the section (which depends completely on frequency); secondly, quality of cooling and water flow through the conductors. Generally, blockage, sedimentation and corrosion of the copper is expected to happen at sections with sharp corners on the inside (water channel), especially if quality of coil water is not suitable. So, it is recommended using sections with curved corners while manufacturing active part of a coil, to prevent the above mentioned matter.

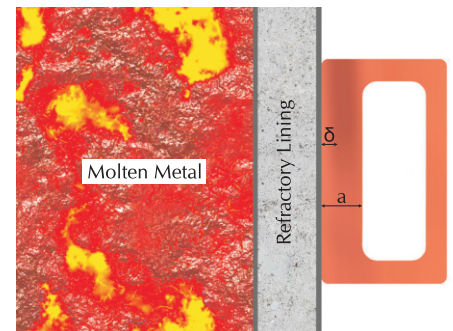





SILVER BRAZING ROD & FLUX

Lawatherm offers these alloys in a wide range of compositions to suit specific applications in the field of maintenance & repair for water pipes (cold & hot water) in copper busbar and squirrel cage rotors.

Silver brazing produces joints that meets specifications which provides excellent flow characteristic, electrical conductivity, pressure tightness, corrosion resistance and service temperature, metal joining operations often employ silver brazing.

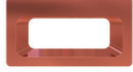

Bonding temp	600-650 deg C
Tensile strength	50000 PSI
Electrical conductivity	5 sm/mm2
Standard size for sq. rod (DIA X LENGTH)	1.5 x 500 MM 2.5 X 500 MM 3.15 X 500 MM 4.0 X 500 MM

Section	Shape	Application
Rectangular Tube with Square Water Passage		Active parts used in Chinese, Indian and Turkish furnaces
Rectangular Tube with Circular Water Passage		Active parts used in American furnaces like Ajax tocco
Rectangular Tube with Oval Water Passage		Active parts used in German Medium frequency furnaces like Otto-junker & ABP
D Shape Section with Circular Water Passage		Active parts used in German low frequency furnaces like Otto-junker & ABP
Pipe (Circular Tube with Circular Water Passage)		Active parts used in some Chinese furnaces
Asymmetrical Rectangular Tube with Square Water Passage		Invented design by Lawatherm used in coil manufactured and designed by Lawatherm

COOLING PART

The main function of cooling parts of a coil is to cool down the upper and lower sections of the coil which carry no currents. Cooling parts are generally made by pipes or rectangular tubes made of stainless steel grade 316 or sometimes like active part of the coil, using copper tubes.



COIL SUPPORT

The main function of coil supports is to keep the gap between the layers and keeping diameter of the coil fixed during the time. They are made of composite insulators. Specifications of an ideal support are as follows:

- High electrical resistance to ensure isolation between loops
- High tensile and flexural strength to endure electromechanical forces
- Ability to absorb minimal moisture to stabilize mechanical and electrical properties during time
- Thermal endurance in proper limitations.



The following table shows a comparison between grades used in quality of supports.

Type of Composite	NEMA Grade	Reinforcement	Resin (Matrix)	Breakdown voltage A/D-48.50	Electrical Strength Abruptly/Continuously	Tensile Strength CW/LW	Flexural Strength CW/LW	Operation Temperature Mechanical/Electrical	Flammability Class	Water Absorption
				KV	KV/mm	Mpas	Mpas	°C	UL94	%
Fiberglass	G-10	Woven Glass Fibers	Normal Epoxy	45 / 40	27.5 / 17.7	245 / 275	345 / 415	140 / 130	H-B	0.25
	G-11		HT Epoxy					180 / 170		
	FR-4		FR Epoxy					140 / 130	V-1	
	FR-5		HT & FR Epoxy					180 / 170		
	GPO-3	Mat Glass Fiber	Polyester	40 / 15	11.8	55 / 55	125 / 125	140 / 120	V-0	
Phenolic Cotton Cloth	CE/LE	Cotton Canvas	Phenolic	23 / 2.5	19.6 / 11.8	62 / 48.5	96.5 / 115	125 / 115	H-B	2.20

Induction Furnace Coil





WATER-COOLED POWER LEADS

Water cooling is one of the most important factors of induction equipment; more than 90% of the problems with melt systems involve water. Most of this boils down to overheated coils, due to restricted water flow in the power leads. Lawatherm has in-house capabilities to make, rebuild or recover all makes and types, as well as to customize a cable for a specific need or application. It is highly flexible together with adequate toughness to help passing the electrical cable assembly through the hose. Copper—rated at 101% electrical conductivity by the IACS and soldered to the terminal to insure optimum contact and conductivity is used.

This cable is covered with a non-conductive hose constructed of a nitrile tube, multi-ply reinforced center and a neoprene cover that protects your cable against damage from heated material, with a 1000-psi minimum burst pressure and a continuous operating pressure of 250 psi. Flange-type terminals are resurfaced and silver plated for optimum contact and electrical conductivity. These are carbon free hose offering an extremely long life through their characteristics of abrasion and weather resistance. They are specially designed and manufactured to take the abuse in the toughest of working environments. These kinds of hoses are mainly used for carrying power cables in electrical induction furnaces, servicing in iron & steel industries for protection from exposure to high temperature, current leakage and radiation from steel furnace, open flame and splashes of hot metal.

WATER COOLED CABLES

Water Cooled Cables transfer electrical power from power source to the crucible of furnace. The power flows through conductors in the cable and the heat created by the high current is removed by the water flow through the cable. Water Cooled Cables include a wide range of models with different material and designs which are used considering electric current running them and type of usage. Lawatherm designs and manufactures different types of Water Cooled Cables using its experimental and technical knowledge and also qualified material. The Water Cooled Cables manufactured in this company are categorized in three main groups:

Type	Applications	Schematic View
Low Power Cables (Secondary Cables)	<ul style="list-style-type: none"> • Welding Equipment & Robots • Electric Pre-heat Furnaces 	
Medium Power Cables	<ul style="list-style-type: none"> • Induction Melting Furnaces (IF) • Laddle Furnaces (LF) 	
High Power Cables	<ul style="list-style-type: none"> • Laddle Furnaces (LF) • Electric Arc Furnace (EAF) 	

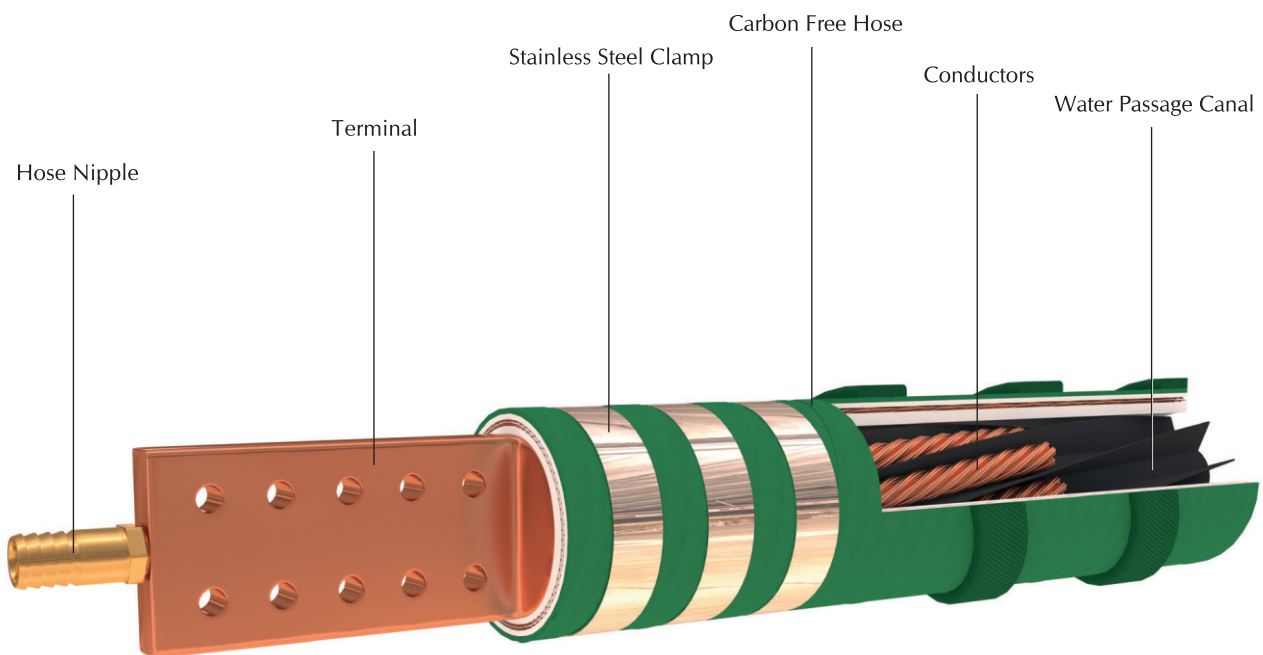

Water Cooled Cable

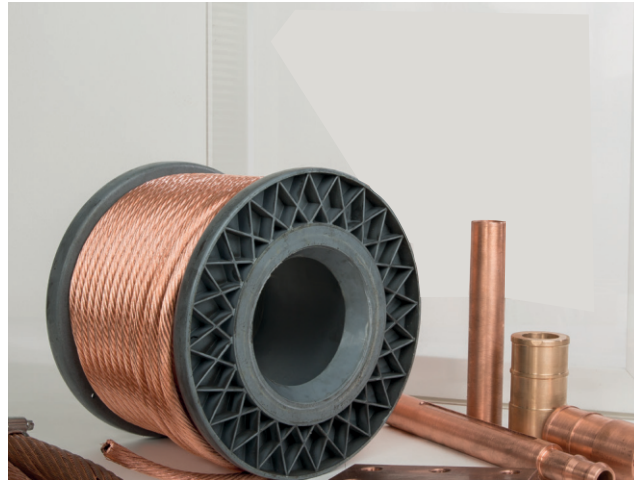

CONDUCTORS

Conductors used in Water Cooled Cables are composed of twisted copper wire strings which are mostly bare and sometimes tin plated (mostly in secondary cables). The copper used for these wire strings is completely softened (annealed) ETP grade Copper (According to ASTM C11000). Water Cooled Cables are divided into two groups regarding arrangement of conductors inside the cable: "Continuous" and "Separated". In continuous Types, conductors of the cables are composed of thin strings in high numbers (with little number of wires); while, the separate cables are composed of conductors with wires in lower numbers which are thicker (or the number of strings is more) compared with the continuous ones. The twist angle of single strings in two adjacent layers are symmetrical.

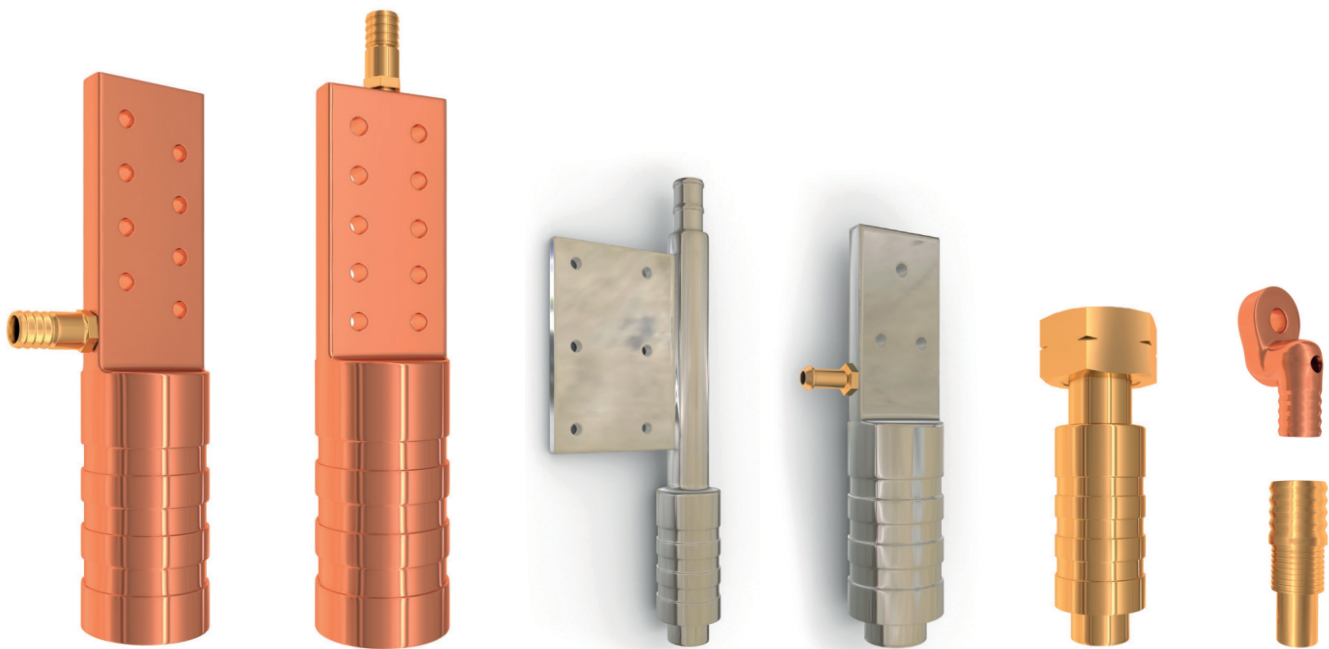

TERMINAL

Cable Heads used for manufacturing Water Cooled Cables are produced as designed in the R&D or according to the drawings provided by customers. Cable heads are generally produced as one-piece through forging and machining copper billets. Sometimes they are as multi-piece through welding machined parts which is not advised especially in high-power cables. Material of the copper used is "ETP grade copper" (according to ASTM C11000) in a softened (annealed) way. The following figure shows some of the convenient terminals (cable heads) used for manufacturing Water Cooled Cables.

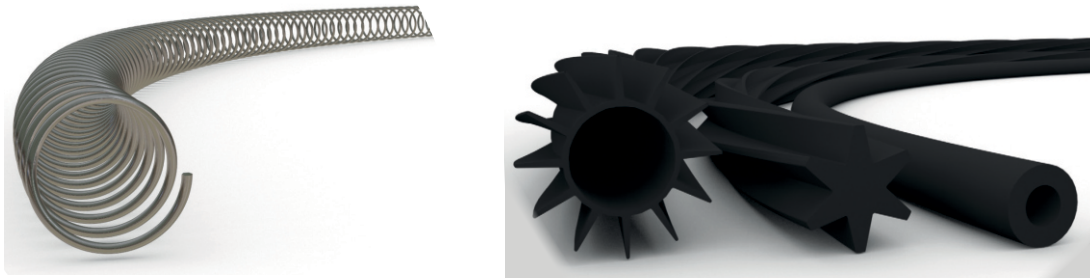

WATER PASSAGE

Water Passage Canals are used by water flow to pass through the Water Cooled Cable; otherwise, water flow will be stopped because of the layers of conductors in the cable. These canals are generally used in the average-power cables and the high-power ones; using them in the low-power ones (Secondary Cables) is not necessary. The said canals are used in two ways:

- Spring type: spring formed, made of stainless steel grade 304 or copper;
- One-piece: have a circle (tube) or polygonal cross section, made of extruded plastic, resistant to corrosion.

Fire-Proof Protective layer for protect hose from melted particle made by Glass fibers or NBR³

Reinforcement layer to prevent hose from rupture made by glass, cotton or synthetic fibers

Inner & middle layer of hose made by carbon free, anti wear, anti corrosion & electric insulator rubber from EPDM¹, XLPE²

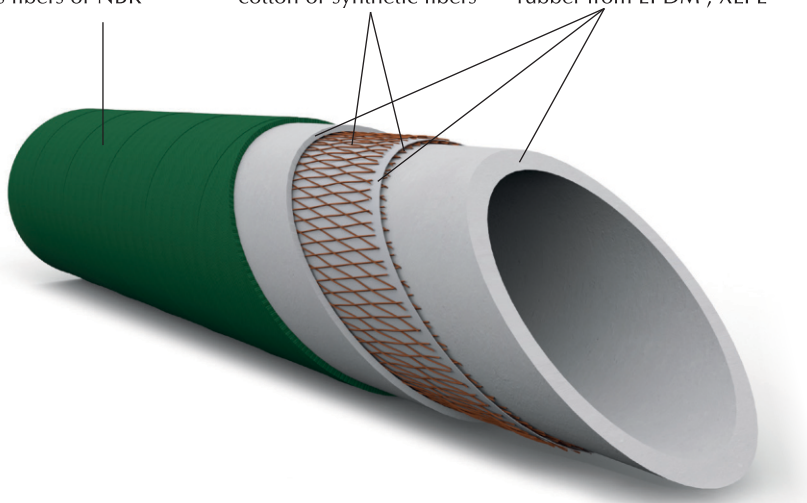

1. Ethylene Propylene Diene Monomer (M-Glass)
2. Cross- Linked Polyethylene
3. Nitrile Butadiene Rubber

HOSE

Hoses used for Water Cooled Cables are made of carbon-free materials and are resistant to corrosion; they are strengthened by woven synthetic fibers in one or two layers to prevent from tearing. Also, the outer surface of hoses is protected using a layer of fireproof material. The maximum working pressure for Water Cooled Cables is 10 to 20 bars in case of continuous usage; the maximum tolerable pressure for them (tearing limit) is about 40 to 50 bars.

HOSE CLAMPS

The fasteners used for sealing hose of a Water-Cooled cable are made of stainless steel to prevent from heating under magnetic field around the furnace. They are used as disposable and toothless to make sure that they won't be opened during the time.



Changeover Switches

CHANGEOVER SWITCH

Changeover Switch is a tool to change the crucible connected to the feeder. These switches are categorized in different types regarding number of input and output; they are introduced based on number of feeders of the furnace and also their crucibles. Generally, number of feeders of an induction furnace is one or two and number of crucibles connected to feeders is two or three. The most convenient type used in changeover switches have one input and two outputs.

Changeover switches are divided into three groups regarding function mechanism: manual, electrical and pneumatic.

- Manual : In this group, changing the crucible is applied using a lever connected to the switch manually.
- Electrical : in this group, changing the crucible is applied using electromotor power.
- Pneumatic : pneumatic changeover switches change crucible from the feeder using pneumatic cylinders. This group is the most convenient ones used in steel industry.

A schematic view of pneumatic changeover switches with one input and two outputs which are manufactured by Lawatherm is as follows:

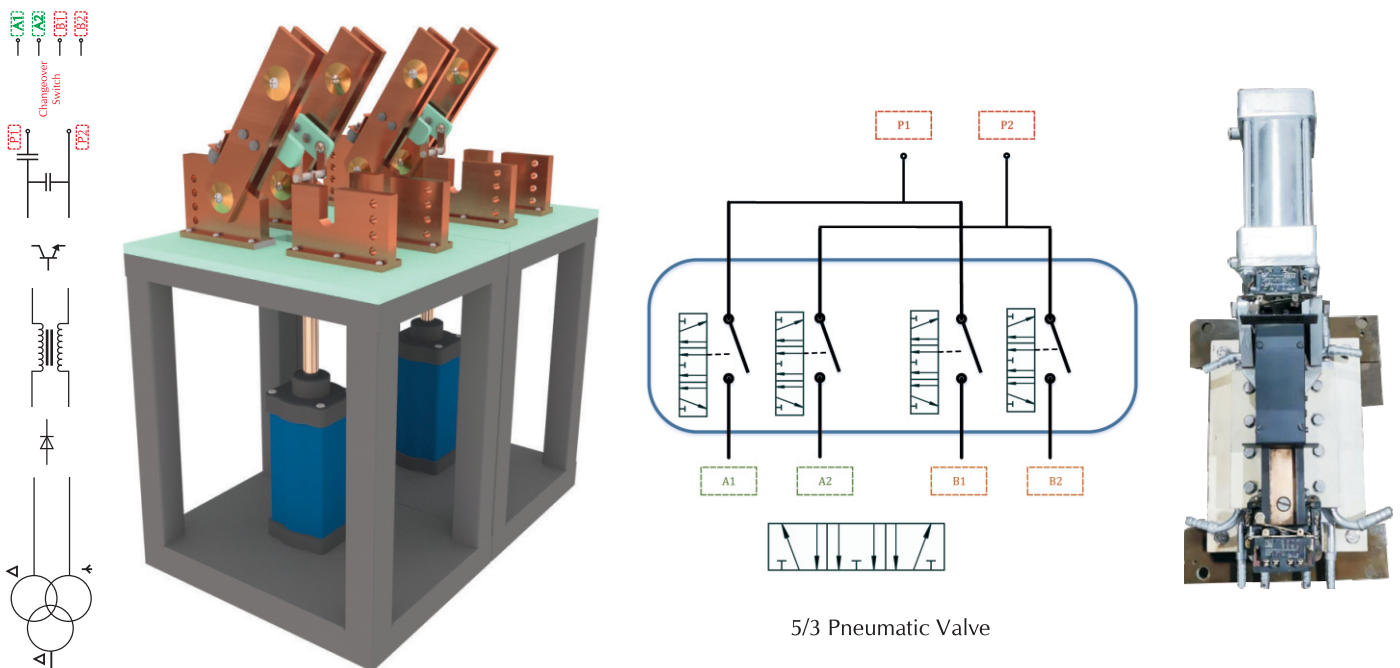

5/3 Pneumatic Valve

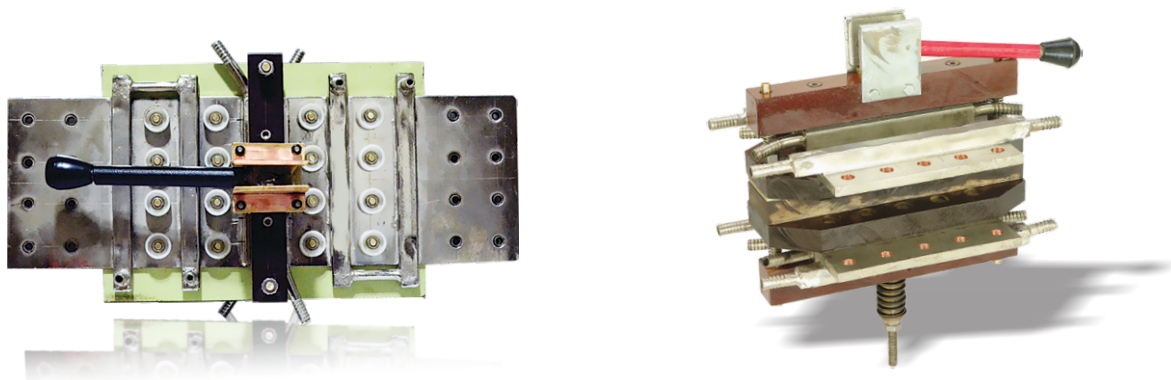

CHANGE OVER SWITCH

The Lawa change-Over Switch is manufactured from high conductivity copper, silver plated. Lawa Change-Over Switch have a double knife contact system, with heavy contact pressure ensure high performance, excellent self cleaning. High short circuit resistance contact are having double breaking and big isolating distances. This ensure excellent and consistent switching performance.



FLOW SWITCH

The Lawa make indicating type, magnetically actuated flow switches are designed for positive detection of fluid flow through your equipment. Flow range covered is from 1 to 150 LPM. Fluid Flow in the System is seen through transparent tube. The clearance between the float and inner surface of the transparent tube are large enough to let floating particles to pass through, eliminating the chances of clogging. This also reduces the pressure drop across the switch. All switches are strong and lightweight. Adequate magnetic shielding is provided as an in-built feature, enabling the user to mount the switch in any location.



PRESSURE GAUGE / PRESSURE SWITCH

Our product is very safely and efficiently designed under the supervision of our highly diligent and hardworking man force such that it is structured to facilitate ensure safe, trouble-free performance. These are known or their brilliant functioning, quality material compatibility, adequate ratings, proper installation, easy operation and maintenance. Our product range includes Vacuum Gauges, Level Gauges and Liquid Level Gauges etc. Our sole aim is to put a smile of contentment on the faces of our customers and do our best in making that possible.



HOSE CLAMPS

The Lawa stainless Steel Hose Clamps are engineered to meet the exact requirements fo our client and within the specify time frame. Our Clamps like heavy duty strip Clamps, Wire Clamps, Worm drive Clamp, have created a strong market presences due to their superior strength excellent gripping and availability in a wide range of designs.



INSULATION

Insulation is the reduction of heat transfer between objects in thermal contact or in range of radiative influence. Insulation can be achieved with specially engineered methods or processes, as well as with suitable object shapes and materials. Lawatherm, is a leading edge manufacturer of insulation products which offers high inherent dielectric strength, mechanical toughness, flexibility and resilience and is widely used in a majority of electrical equipment applications. Our steel Industry products and services help ensure safety, enable lighter designs and reduce maintenance costs of equipment - especially for melting furnace.

Lawatherm technology helps develop that utilized energy more efficiently, require low maintenance, with zero compromise on safety and long-term performance and we continue to innovate. Whether you are in the oil and gas, automotive, chemical, agricultural, food processing, manufacturing, or maintenance businesses, there's an industry - leading Lawatherm material suited to the job you need to get done. Lawatherm has readily available in-depth stocks of a wide range of insulation products including some of the best brands i.e. Lebond, Dupont, Dr.Beck, Thermosil, Arco, Champion, Charminar etc.



FLEXOCOAT 2216 BASE/HARDENER

Lawtherm is a specially designed durable, high dielectric insulating material, which replaces old style epoxies, polyester and varnishes insulation systems. Application of these materials is crucial. This is why special heating equipment to properly cure the insulation is required with these materials. Utmost care should be given to apply the material to provide uniformity of application.

Maximum precaution is taken to insure that the first layer of insulation is applied to the accurate amount of thickness and properly cured before the second coat is applied. If the first coating is too thick or not properly cured, “outgassing” can occur, causing turn to turn arcing and premature failure of the coil. Special high-voltage electrical tests are carried out on the entire coil to insure the integrity of the insulation. Lebond 2216 has been heated to 450°F and subjected to high voltage non-destructive tests [up to 6000 Volts DC] with no indication of failure. Flexocoat lebond 2216 for coating induction coils of electric induction furnace, it has excellent adhesion on copper and stainless steel desired flexibility to withstand cooling and heating cycles normally encountered during operation of furnaces and provides electrical resistance to voltage developed between the coils to protect from sparking, upto approximately 400 volts/mill. Thickness of coating.



FRP (FIRE RETARDANT PROOF) PRODUCTS

Lawtherm manufactures Fiberglass products (Epoxy and Polyester) in various sizes and shapes of Sheet, Flats (coil Support/Bar), Rods, Tubes, Spacer, Angles & sections. These sections being made from epoxy resin and glass fibers combined together give an excellent performance that combine high strength and excellent electrical insulating characteristics for use in a variety of applications where electrical insulation and non-corrosive material is required in the electrical and thermal insulation industry. The company believes in ‘providing satisfactory solutions and assistance’ to the clients. With zeal to achieve consistent growth, the company strives on customer satisfaction as its main motto. A variety of custom built sections can also be made upon demand of the customer.

GRADES

G-10 and G-11 (Glass Cloth / Epoxy Resin)
This glass epoxy laminates are specified for their extremely high stability over temperature, G-10 and G-11 are used for terminal Board, insulation in electro magnet separators, High humidity applications, LV and HV circuit breakers, Electric Rotor Insulations, and where strength to size ratio is critical, G-10 is stronger while G-11 is a better insulator and can take higher temperature.

FR-4 (Glass Cloth / Epoxy Resin)

FR-4 is Fire Retardant G-10 Glass Epoxy laminates

Typical Properties of Glass Epoxy Laminates			
Characteristics	Unit	G-10	G-11
Colour		Light Green / Yellow	Light Green
Thermal Class		F/H	H
Specific Gravity	Gm/cm ³	1.8 - 1.82	1.8
Tensile Strength	Psi	38,000	37,000
Comp. Strength	Psi	65,000	63,000
Flexural Strength	Psi	60,000	70,000
Hardness	M Scale	M115	M112
Bond Strength	Psi	2300	2200
Shear Strength	Psi	21,500	22000
Dissipation Factor	10 ⁶ cycles	0.032	0.032
Dielectric Constant	10 ⁶ cycles	4.8	4.5
Electrical Strength	KV / MM	40	45
Arc Resistance	Sec	100	120
Flammability Rating		94V-0	94H-B
Max Oper. Temp.	°C	140	180
Coeff Thermal Exp.	IN/IN/°C X 10-5	0.1	0.2
Water Absorption	% - 24 hrs	0.1	0.2
Shelf Life	25 °C	>24 months	>24 months

Insulation Materials Used In Induction Furnaces

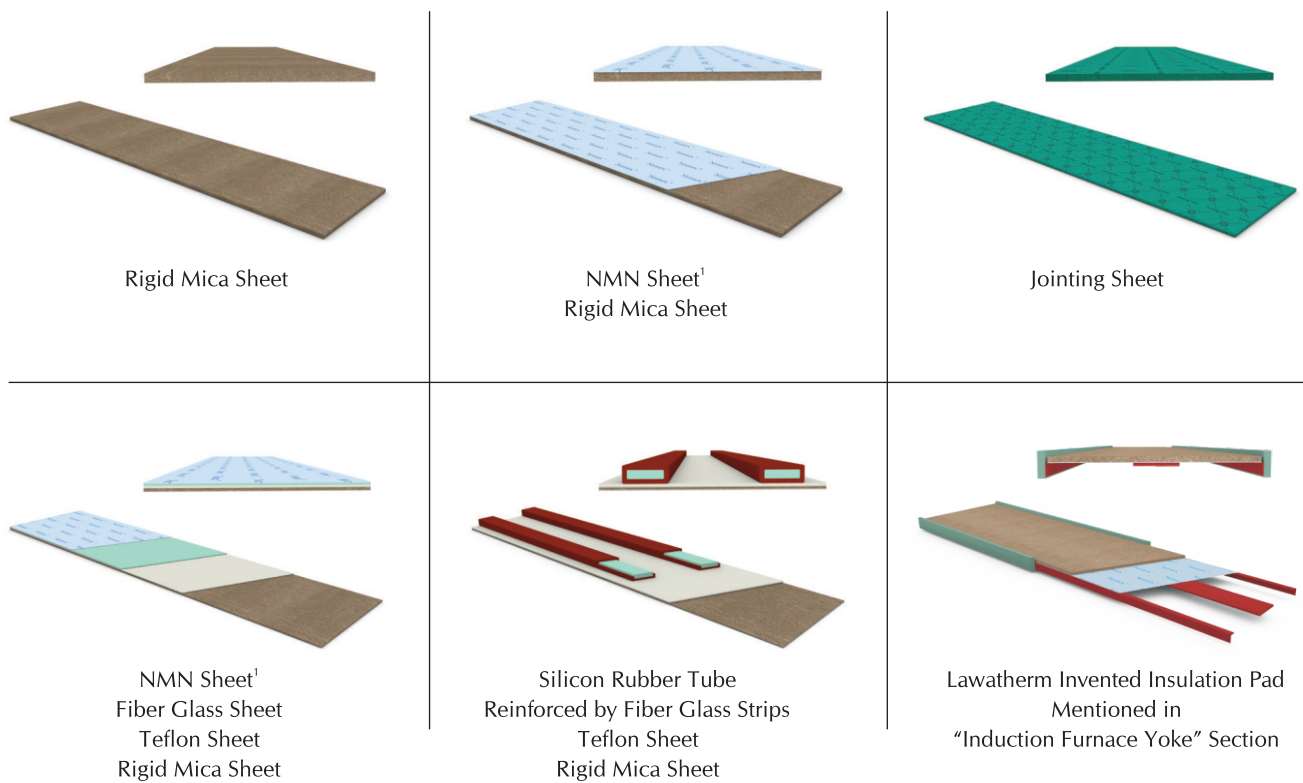

1. Consist of three layers: Nomex - Mylar - Nomex

INSULATION PAD

Insulation pad is a set of insulating layers placed between the coil and the yokes of an induction furnace which are used to isolate them. Lawatherm provides insulation pads in different types with special properties and applications. The following images show compositions and layers of provided insulation pads by this company.

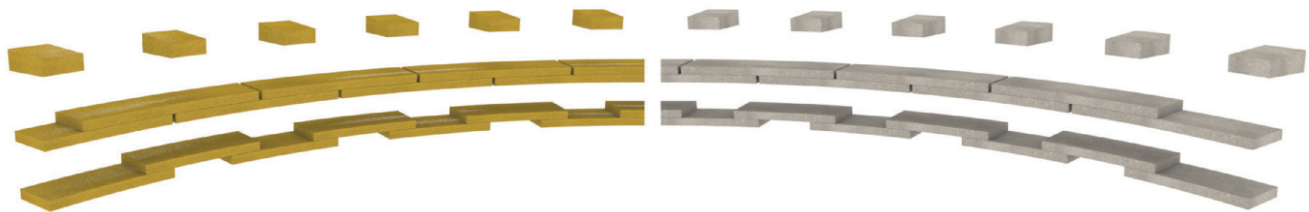

SPACER

Using insulation materials in all the electrical parts of an induction furnace is very important and inevitable. Any small insulation defect may lead to an error or a short circuit, and thus an stoppage of melting process in a furnace. Spacers should be necessarily applied between loops of a coil. Spacers strengthen the coil's coating in addition to reinforcing insulation power in the space between loops of a coil. Spacers are divided into groups regarding their material: Mica and Fiberglass; They are also divided into two groups regarding their form: lunate spacers and wedge spacer. Lunate spacers are used in a continuous mode and the wedge ones are used in an interrupted mode.

- Mica spacers have more thermal capacity compared with the fiberglass ones and instead, they cost more.
- lunate spacers provide more electrical and mechanical strength compared with the wedge ones.
- The continuous lunate spacers are produced through machining and overlaying with a certain overlap. (0 to 50 percent overlap) More overlap means more strength and so, more assurance. Instead, in this case moisture outlet will be more difficult during sintering.

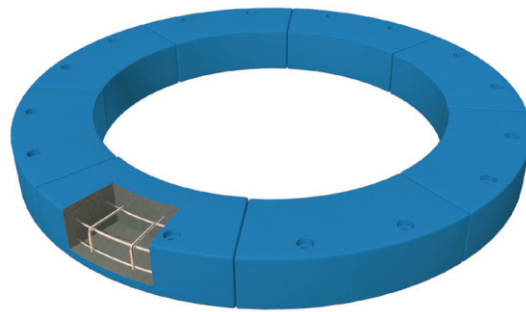

REFRACTORY BLOCKS

Refractory blocks are installed between the coil and the structure, at the upper and lower sections, as isolator. They are manufactured by moulding Alumina (50 percent purity and having fibers) in the desired form and dimension. Metallic non-magnetic material is used during moulding to reinforce concrete and prevent from fragility. Refractory blocks are used in “One-piece” or “Multi-piece” way. The advantage of using multi-piece types is to provide space between blocks to prevent their cracking because of expansion as a result of furnace heat.

No.	Item	Convenient Material
1	Top Ring	Alumina ¹ 50%
2	Molten Metal Bath	
3	Furnace Coil	Special Copper Tubes
4	Grout Coil	Alumina 95%
5	Bottom Ring	Alumina 50%
6	Middle Isolator Layer	Mica-based Compositions Roll Layer
7	Refractory Lining ²	Silica Ramming Mass or Magnesium Aluminate Spinel
8	Earth Leakage Rod (Antenna)	

1. Al₂O₃
2. Hot Face Lining

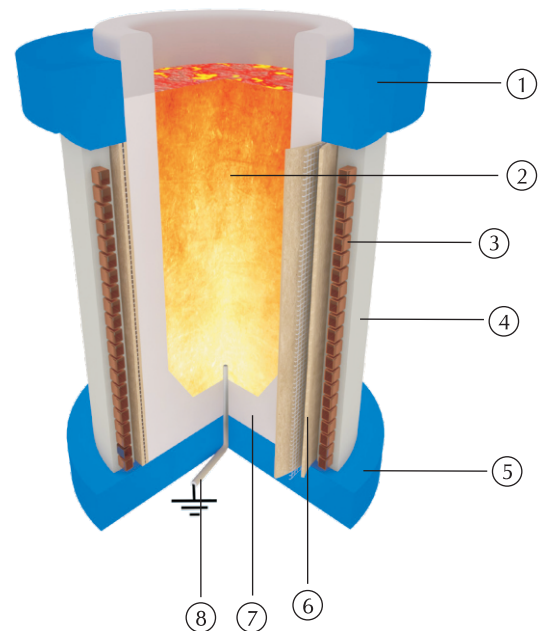

ISOLATOR BETWEEN THE REFRACTORY AND THE COIL GROUT





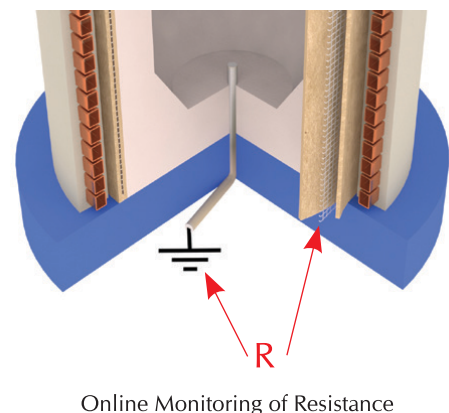





This isolator is used behind the refractory lining of induction furnaces to isolate coil grout from the refractory materials. These isolators prevent the leakage of the melt to penetrate the coil grout. In addition, a specific type of these isolators is used as a part of melt leakage warning system and are generally produced and used as a roll of flexible mica-based material in different grades. A table on the next page shows different grades of rolls which can be used and provided by Lawatherm.

In case of using the material which is mentioned at No. 2 of the table, melt leakage warning system that is suitable with this material, may be used. To achieve this, at first, the required modifications should be applied to furnace system and then, a special resistance measuring instrument that is being provided by Lawatherm should be installed to measure and monitor momentary resistance between middle layer of the isolator (non-magnetic SS layer) and the earth neutral (that is already connected to melting by antenna). This way, in case of gradual leakage of the melt and its approach to the isolator layer, the measured resistance gradually reduces and in case of dropping more than the amount defined before, the installed system warns and even sends trip order in case of emergency. This method is one of the effective and cheap methods for melt leakage warning system in a furnace.



Online Monitoring of Resistance

Insulation Materials Used In Induction Furnaces

No.	Layers	Technical Properties			Dimensions			Description	Schematic
		Heat Transfer Coefficient ¹ (W/m ² °C)	Maximum Tolerable Temperature (°C)	Electrical Strength ² (KV/mm)	Roll Length (m)	Roll Width (mm)	Thickness (mm)		
1	Flexible Phlogopite Mica Sheet	0.20	1000	> 18	Max 2.4	1000	0.1-0.6		
2	<ul style="list-style-type: none"> Flexible Phlogopite Mica Sheet Antimagnetic Stainless Steel Net Flexible Phlogopite Mica Sheet 	0.25	1000	> 23	Max 2.4	1000	0.9 ± 0.1	This case is used in furnaces equipped with leakage diagnosis based on them	
3	<ul style="list-style-type: none"> Flexible Muscovite/ Phlogopite Mica Sheet Woven Glass Fibers 	0.35	Mus = 1000 Ph = 1200	Mus > 25 Ph > 23	Max 300	500 or 1000	0.14-0.49	-	
4	<ul style="list-style-type: none"> Flexible Muscovite/ Phlogopite Mica Sheet Woven Glass Fibers Flexible Muscovite/ Phlogopite Mica Sheet 	0.35	Mus = 1000 Ph = 1200	Mus > 25 Ph > 23	Max 300		0.14-0.49	-	
5	<ul style="list-style-type: none"> Fiber Glass Mat Flexible Phlogopite Mica Sheet Woven Glass Fibers 	0.35	1200	> 23	Max 100	1000	0.40		
6	<ul style="list-style-type: none"> Fiber Glass Mat Flexible Phlogopite Mica Sheet Woven Glass Fibers Fiber Glass Mat 	0.35	1200	> 23	Max 100	1000	0.4 pr 0.5		
7	<ul style="list-style-type: none"> Woven Glass Fibers Flexible Muscovite/ Phlogopite Mica Sheet Calcium Silica Soluble Fibers 	0.10	1100	Mus > 25 Ph > 23	12.5 20 25	500 or 1000	2.3-3.3		
8	<ul style="list-style-type: none"> Flexible Muscovite/ Phlogopite Mica Sheet Woven Glass Fibers Calcium Silica Soluble Fibers 	0.10	1100	Mus > 25 Ph > 23	12.5 20 25	500 or 1000	2.3-3.5		
9	<ul style="list-style-type: none"> Calcium Silica Soluble Fibers 	0.60	1100	-	10 15 20 25	500 or 1000	1-10		
10	<ul style="list-style-type: none"> Woven Glass Fibers Flexible Micro-particle Phlogopite Mica Sheet Calcium Silica Soluble Fibers Special Aluminium Alloy 	0.10	1100	> 23	According to the Order		2.4	This case is used to prevent penetration of Zinc towards the coil	
11	<ul style="list-style-type: none"> Flexible Micro-particle Phlogopite Mica Sheet Fiber Glass Mat 	0.10	900	> 23	20	1000	0.65 ± 0.05	-	

1. In 400 °C 2. According to IEC60243 Standard in 20°C

MICA PRODUCT

Lawatherm manufactures Mica products in various sizes and shapes of Sheet, Rods, Tubes, Tapes(PSA), Spacer, Half round mica turn & also lifting magnet insulation spares.

Composition

It consists of several layers of muscovite mica paper impregnated with silicone binder pressed under heat & pressure to yield plate / board having excellent mechanical, thermal and electrical properties.

Application

- Insulation of high temperature heated platens and moulds in hydraulic and presses
- High temperature insulation of electrode arm in arc furnaces and ladle furnaces
- High temperature insulation between coil and crucible in induction furnaces
- Insulation in dynamic braking resistors used in locomotives
- Applications requiring high voltage resistance at high temperatures

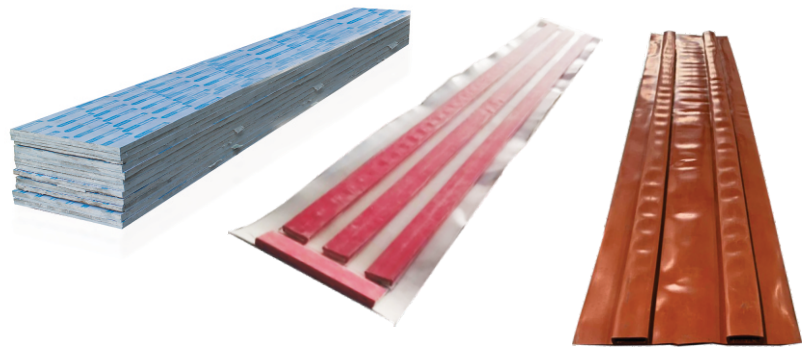

Mica Type		Muscovite
Colour		Brown
Mica Content	% Min	90
Resin Content	% Max	10
Density	Gm/cm ³	2.1 - 2.25
Heat Resting Continuous	°C	800
Heat Resisting Intermittent	°C	1000
Dielectric Strength @23°C	KV/mm	> 18
Edge Strength	Kg/0.1mm	0.9
Tensile Strength	N/mm ²	100
Flexural Strength	N/mm ²	> 180
Weight Loss @550°C for 4Hrs	%	< 1
Water Absorption	%	< 0.5



ASBESTOS MILL BOARD

This is a versatile, thermal insulation and heat-resistant material produced in sheet form using good quality asbestos fibres, incombustible fillers and vegetable binders. It does not suffer loss of strength upto 485°C. When suitably supported the board can be used satisfactorily at extreme temperatures upto approx. 1400°C.

Service

For all kinds of thermal insulations ranging from domestic cookers and ironing boards to industrial applications such as glass moulding, ovens and furnaces and domestic stoves. As the sheets can be bent to any diameter with a little moisture, they are most suitable for large diameter pipe cladding.

Particulars	Units	Test Results
Density (Nominal)	gms/cc	1.15
Tensile Strength	kg/cm ²	20
a. Along Grain (Min.)	kg/cm ²	10
b. Across Grain (Min.)		
Loss on ignition (Max.)	%	15
Moisture content (Max.)	%	2
Thermal Conductivity	W/moc	0.116
Electrical Strength	kv/mm	1.5
Temperature Resistance	500oC or higher if suitably supported	
Flame Test	Does not get burnt when held in flame	
Thickness Availability	There is no separate specification for asbestos free material. However the properties of the asbestos free material match closely with those of the asbestos material.	
Specification Compliance		

Insulation Materials Used In Induction Furnaces



TEFLON SHEET

Lawatherm is one stop shop for electrical insulating materials and composites of Engineering Plastic Products. The Teflon (PTFE resin skived) sheet are highly dielectric, chemical resistant and not ageing. They have a wide range of operation temperature range between -260°C to 260 °C. Over a scientific study done a vast range of component which have excellent property of fluoro based which show excellent mechanical behavior like hardness, longitudinal strength, mechanical strength and specially chemically inert for both type of reaction whether acidic or basic. Teflon (PTFE resin skived) sheet are available in continuous rolls or cut to the desired length. Composite materials in the form of Sheets, Boards, Hollow Pipes, Solid Geometrical Profile are used for making fabricated parts as per customer requirements. These process may involve Cutting, Turning, Sawing, Shearing, Punching, Dowelling, Chamfering, Thickening, Scarfing, Drilling, Shaping, Routing, Scoring, Milling, Grinding, Tapping, Threading Pasting finishing packing etc. all operation being performed by skilled person with advance technology machines. A detailed quality check from procurement of raw material to in process and then at final product level is done to ensure fitment to use as per customer expectation. Available machined components matched to exact specification / drawings.



PARMALI (DENSIFIED LAMINATED) WOOD PRODUCTS

Lawatherm is one stop shop for electrical insulating materials and composites of Parmali wood. The Parmali (Densified Laminated) wood boards for insulation application such as coil-clamping rings, pressure / potential rings, coil supports, spacers, and lead supports etc. Our materials possess extra high voltage insulating characteristics and are used in EHV transformers, large electrical machines, hydro and turbo generators, High voltage switchgears etc. Composite materials in the form of Sheets, Boards, Hollow Pipes, Solid Geometrical Profile are used for making fabricated parts as per customer requirements. These process may involve Cutting, Turning, Sawing, Shearing, Punching, Dowelling, Chamfering, Thickening, Scarfing, Drilling, Shaping, Routing, Scoring, Milling, Grinding, Tapping, Threading Pasting finishing packing etc. all operation being performed by skilled person with advance technology machines. A detailed quality check from procurement of raw material to in-process and then at final product level is done to ensure fitment to use as per customer expectation. Available machined components matched to exact specification/ drawings.



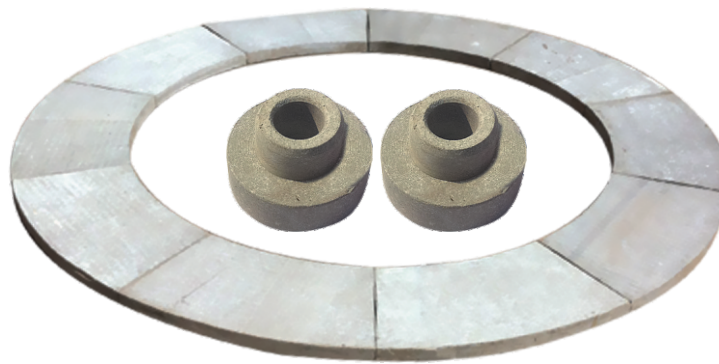

SINDHANIO PRODUCT

Lawatherm is manufacturing syndino products in various size and shapes of sheet, rod, spacer, segment, half round syndino turn, top & bottom. These sheets are available in various sizes from 2mm to 75mm.

Composition

Lawatherm consist of asbestos fiber and cement formed into fully compressed boards under high pressure, mechanically strong, these boards possess good arc and heat resisting characteristics are used for thermal insulation as well as electrical insulation.

Application

- Insulation of high temperature heated platens and moulds in hydraulic and presses
- High temperature insulation of electrode arm in arc furnaces and ladle furnaces
- High temperature insulation between coil and crucible in induction furnaces
- Insulation in dynamic braking resistors used in locomotives
- Applications requiring high voltage resistance at high temperatures

Specification	Requirement As per IS:4248	Sindhania 450 Obtained Value
Continuous Operating Temperature		450 °C (Max)
Density (Kg/m ³)		1900
Thermal Conductivity (W/m OK)		0.64
Cross-breaking strength (Kg/cm ²)	Min. 300	366
Crushing Strength (Kg/cm ²)	Min. 1055	1536
Shear Strength (Kg/cm ²)	Min. 210	437
Deformation under Compression, Kgf	Reduction in thickness shall not be greater than 5% nor	Reduction in thickness: 2 %



NOMEX PAPER

Nomex paper is an insulation paper which offers high inherent dielectric strength, mechanical toughness, flexibility and resilience. Nomex paper is the original form of Nomex paper, and is widely used in a majority of electrical equipment application. Available in 11 thicknesses (0.05 to 0.76mm) (2 to 30mil), Nomex paper is used in almost every known electrical sheet insulation application.

Table I - Typical electrical properties

Nominal Thickness (mil) (mm)	2 (0.05)	3 (0.08)	5 (0.13)	7 (0.18)	10 (0.25)	12 (0.30)	15 (0.38)	20 (0.51)	24 (0.61)	29 (0.73)	30 (0.76)
Dielectric strength AC rapid rise (V/mil) (kV/mm)	460 18	565 22	715 28	865 34	845 33	870 34	850 33	810 32	810 32	760 30	680 27
Full wave impulse ² (V/mil) (kV/mm)	1000 39	1000 39	1400 55	1400 55	1600 63	N/A N/A	1400 55	1400 55	N/A N/A	N/A N/A	1250 49
Dielectric constant ³ at 60 Hz	1.6	1.6	2.4	2.7	2.7	2.9	3.2	3.4	3.7	3.7	3.7
Dissipation Factor ³ at 60 Hz (x 10 ³)	4	5	6	6	6	7	7	7	7	7	7

Induction Furnace Yoke



Full-Welded with S.S¹ Cooling

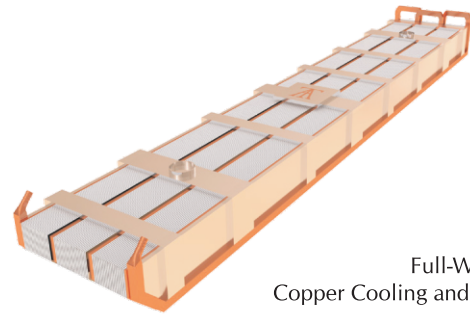

Full-Welded with Copper Cooling and S.S Holder

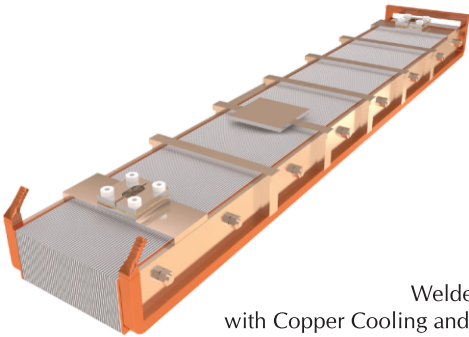

Welded & Bolted with Copper Cooling and S.S Holder

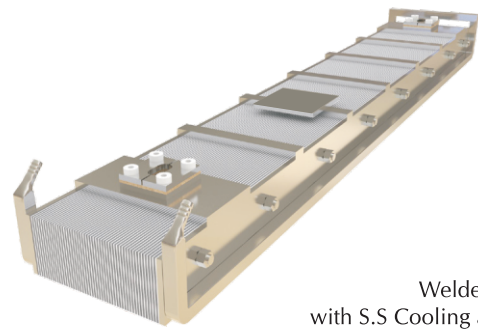

Welded & Bolted with S.S Cooling and Holder

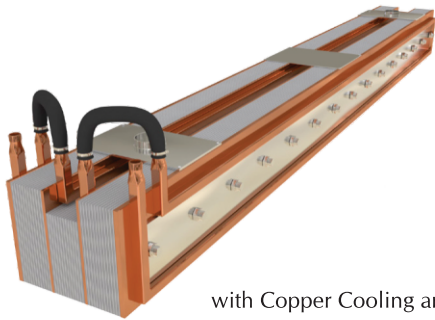

Full-Bolted with Copper Cooling and S.S Holder

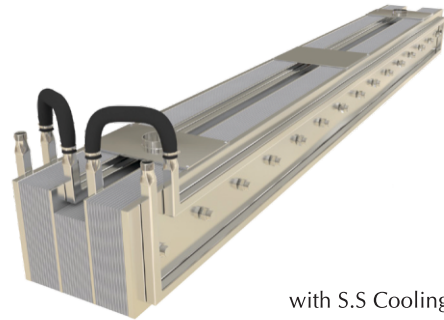

Full-Bolted with S.S Cooling and Holder

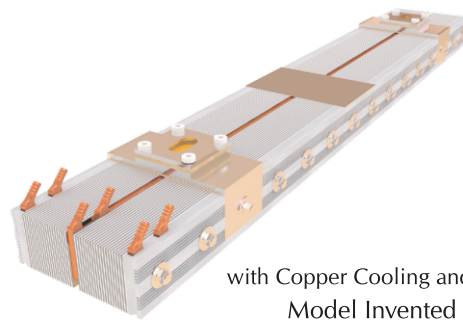

Full-Bolted with Copper Cooling and Aluminium Holder
Model Invented by Lawatherm

1. Stainless Steel

MAGNETIC YOKES (SHUNTS) OF INDUCTION FURNACE

Magnetic Yokes of Induction Furnace collect and conduct the magnetic field produced by the coil. The better the material used in the core the higher the furnace efficiency and lower the thermal losses. Also, quality and geometric structure of the yoke affects uniformity of magnetic flux dispersion inside the furnace, turbulence created by the field and quality of melting. Lawatherm manufactures different kinds of magnetic yokes according to the drawing or designs provided by customers or according to its own design based on the application conditions of the customers, using cutting-edge technology and its experienced staff.

A schematic view of convenient models of yokes used in the induction furnaces is as follow:

The main parts of a yoke which should be considered while design, are: core, cooling system, assembly and connector. Properties and specifications of each element are as follows:

Type	Grade	Thickness (mm)	Iron Losses at 50 Hz			Magnetic Saturation Point ^d (T)
			B = 1 T	B = 1.5 T	B = 1.7 T	
CRGO ¹	M3	0.23	-	0.73-0.80	1.10-1.27	1.75-1.78
	M4	0.27		0.80-0.89	1.20-1.40	
	M5	0.30		0.85-0.97	1.25-1.50	
	M6	0.35		1.00-1.11	1.40-1.65	
Hi-B ²	M3	0.23	-	-	0.85-1.00	1.85-1.88
	M4	0.27			0.90-1.03	
	M5	0.30			1.00-1.11	
	M6	0.35		1.25		
CRNGO ³	M-290	0.50	1.15	2.9	-	1.49
	M-310		1.25	3.1		
	M-330		1.35	3.3		
	M-350		1.50	3.5		1.50
	M-400		1.70	4.00		
	M-470		2.00	4.7		
	M-530		2.30	5.30		
	M-600		2.60	6.00		

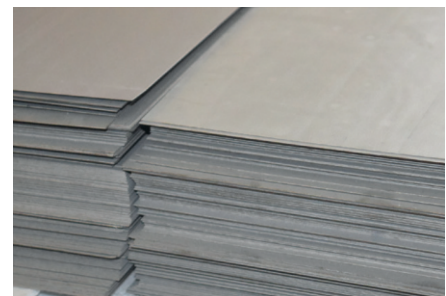
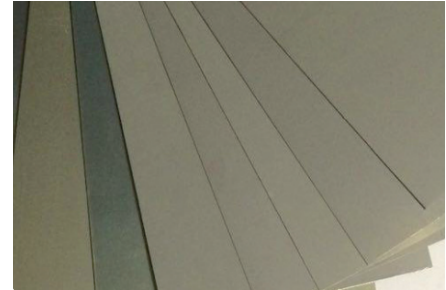

CORE

The core of a magnetic yoke is composed of magnetic sheets of various materials. Quality and thickness of the used sheets affects magnetic permeability and flux integration, amount of energy losses and as a result, furnace efficiency. Main Factors affecting the said matters are briefly as follows:

- Thickness of the sheets
- Amount of silicon in the Material
- Dispersion of silicon grains along the sheet
- Magnetic saturation point

The above mentioned factors lead to loss reduction in mass unit, effective life time and magnetic flux capacity. The following table shows a comparison between grades of the used sheets in the core of magnetic yokes produced by Lawatherm

1. Cold Rolled Grain Oriented
2. High permeability cores including: MOH, Laser, ...
3. Cold Rolled Non-Grain Oriented
4. The least guaranteed density of magnetic field which leads to core saturation; this amount is estimated at 800 (A/m) magnetic field intensity for CRGO and Hi-B core sheets and 2500 (A/m) for CRNGO

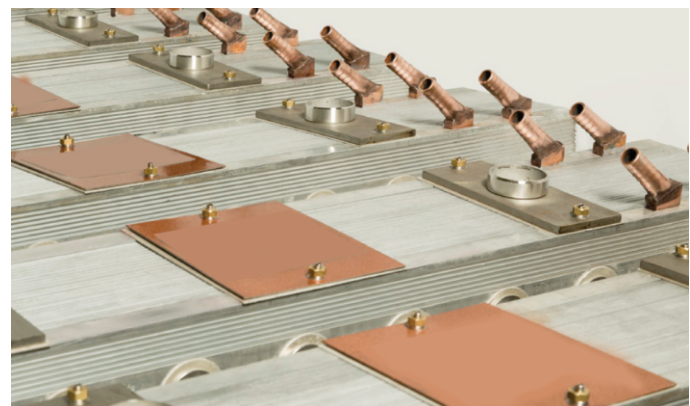

Induction Furnace Yoke

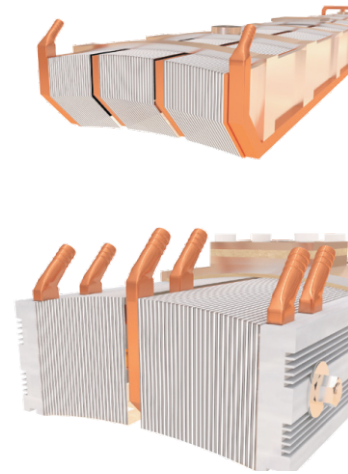
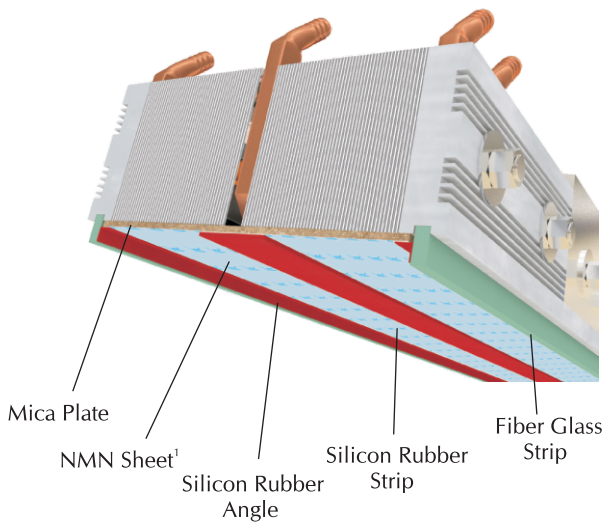

1. Consist of three layers: Nomex - Mylar - Nomex

YOKE BASE

Base of the yoke means the way yoke sits on the side of the coil. The base may be flat or curvature. Curvature based Yokes provide better mechanical stability compared with the flat based ones. Also, curvature based yokes prevent attraction of dust to the space between yoke and the coil and reduce probability of short circuit between them. Instead, flatbased yokes provide better conditions for discharging vapour produced by sintering the refractory lining, compared with the curvature-based ones.

To attain the advantages for both “flat-based” and “curvature-based” models Lawatherm is providing special insulation pads on its newly invented yokes (full-bolted with copper cooling and aluminium holders). By using this special insulation pads with the yokes you can have the option for discharging sintering vapour while retaining mechanical stability of the yoke and prevent penetration of the dust to the space between the yoke and the coil.

It should be mentioned that considering excessive complexity of manufacturing curvature full-Bolted yokes, all the manufacturers across the world produce the flat bolted models. While, Lawatherm is able to manufacture all the models of yokes including full-welded, full-bolted and welded-bolted models in two forms of flat and curvature, using its invented technology.

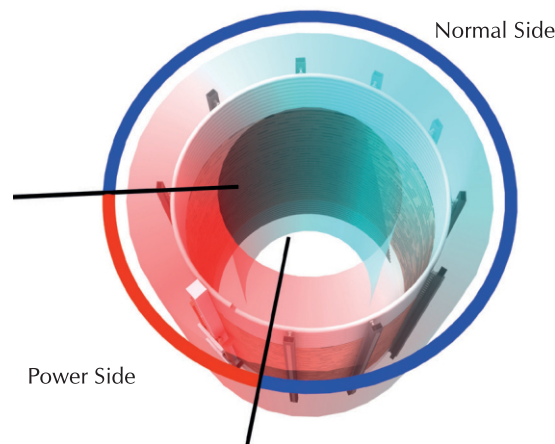















COOLING SYSTEM

The main function of cooling system is thermal exchange and cooling down the yoke’s core which is heated because of magnetic field flow. Design of the Cooling system is based on water flow through lateral and middle cooling sections of the yoke and the number and places of cooling sections in each yoke is determined by the furnace power, number and place of yokes and water feeding system of the furnace.

Considering density of magnetic field around the coil, this region is divided into two parts:

- Power-Side: space around the coil I/O which magnetic field has higher density because of the magnetic field created by the water cooled cables.
- None-Power Side: the remaining space around the coil which magnetic field’s density is less than Power-Side.

Obviously the cooling system used for “Power-Side” yokes should be more effective because of stronger magnetic field. This matter is generally achieved by adding middle cooling sections to the yoke and sometimes by changing material used for making cooling sections.

No.	Yoke Type	Design	Section
1	Full-Welded with S.S Cooling		
2	Full-Welded with Copper Cooling and S.S Holder		
3	Welded & Bolted with Copper Cooling and S.S Holder		
4	Welded & Bolted with S.S Cooling and Holder		
5	Full-Bolted with Copper Cooling and S.S Holder		
6	Full-Bolted with S.S Cooling and Holder		
7	Full-Bolted with Copper Cooling and Aluminium Holder		

Induction Furnace Yoke

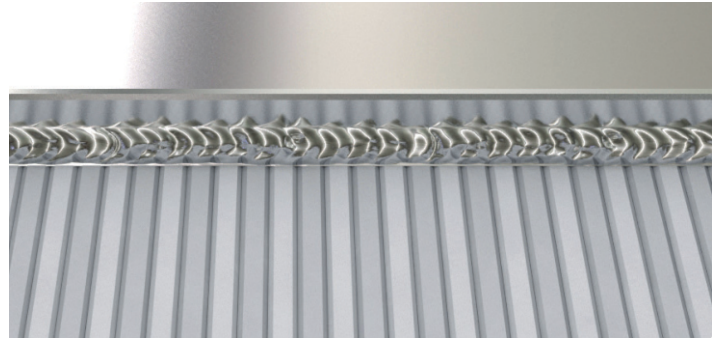
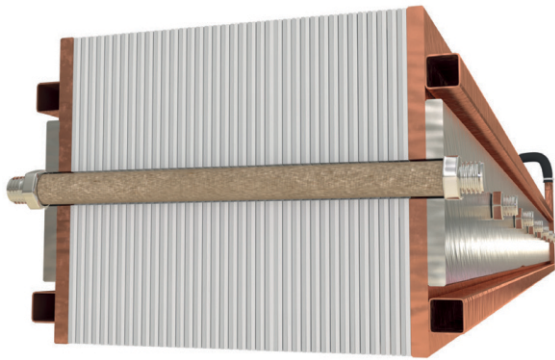

ASSEMBLY OF THE YOKE

The various parts of the magnetic yokes may be assembled together in two ways: through “Bolting” or through “Welding”. The major advantage of bolted yokes is that they can be disassembled in case of breaking down and defected parts can be replaced. Also, the bolted yokes have less Foucault losses than welded types because of not using welding for connecting sheets of the core together and to the body.

The other problem that is encountered in full-welded yokes is the lower part of the yoke being dissipated and opened up that leads to distance between sheets of the core. In the other words because the connection between all the parts is only on the surface of the yoke, the lower part of the yoke that places next to the coil begins to dissipate and open up because of the tension shifted from the welded points on the surface and the pressure of the structure bolts. This opening and the distance between sheets of the core causes intense sounds during application and worse, swarf and dust are attracted to the space between sheets of the yoke. These dust later can cause short circuit at the furnace.

Corrosion By Time	Carbonizing Capability Excess the Tolerable Temperature	Thickness (mm)	Water Absorption	Flexibility	Maximum Continuous Tolerable Temperature (°C)	Section Image	Material Of Bolt Isolator
High	Yes	1.5	High	Non-flexible	500		Mica Tube
No	No	2.0	Zero	Very High	280		Special Silicon Hose
No	No	0.22 Four layers	Zero	Low	400 For Tape 280 For Resin		Twisted Kapton Strips



CONNECTOR OF THE YOKE

In fact, connector of the yoke is the mediator between yoke's body and the structure bolts which fix the yokes at their place; it is designed and built according to the furnace cradle and installed on the yoke in the ways suggested by Lawatherm. Some convenient models of yoke connectors manufactured in this company, are provided. These models are categorized in two main types regarding their application: "Push" models and "Push-Pull" models. The "Push" model connectors are used only for applying pressure on yoke to attach it to the coil; whereas, "Push-Pull" connectors are used for separating yoke from the coil in case of need, in addition to attaching it to the coil.

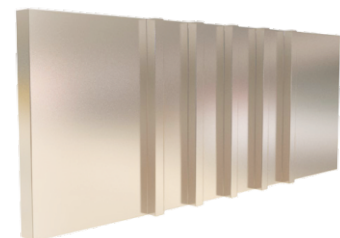
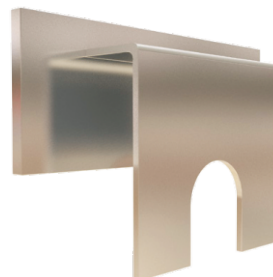
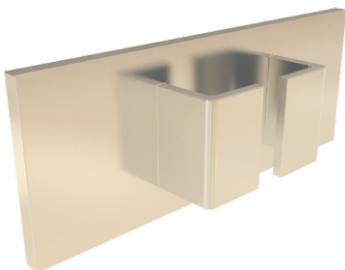
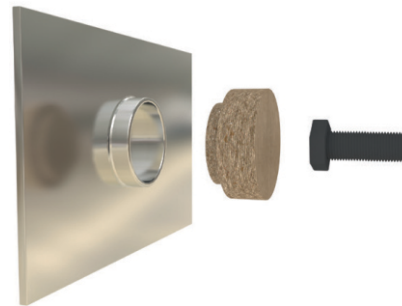
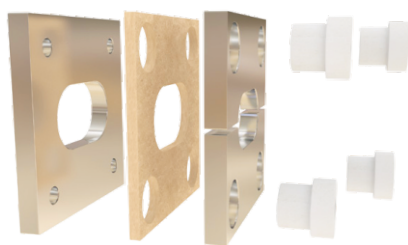

Reactor (Choke)

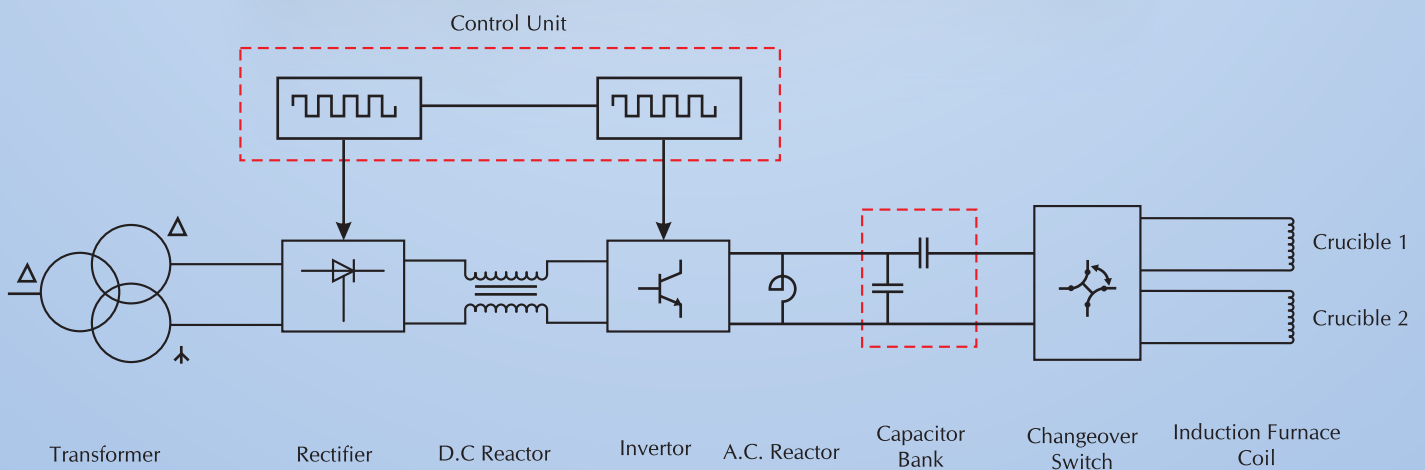

Our range of transformers oil water coolers can be supplied in different mounting variants. The standard water cooler version is designed for direct mounting to the transformer tank. In addition, our range of products comprises free-standing transformer oil coolers designed to customer specifications. The coolers in general are used for specific types of transformers, such as furnace transformers or rectifier transformers. A further application is machine transformer cooling at hydraulic power plants.

DESCRIPTION

Unlike tube bundles of single-wall design, double-tube bundles are provided with two tube sheets at each end. If a tube wall shows a leak, the product flows through fine ducts arranged between the double tubes into the leakage collection space and triggers a check command. However, the second remaining undamaged tube keeps the fluids separated. The plant operator may continue to run the heat exchanger until the next scheduled maintenance, thus avoiding cost-intensive shutdown times. We have been supplying double-tube coolers for more than thirty years. Today, double-tube safety heat exchangers are state-of-the-art for transformer oil water coolers.

Transformer oil water coolers are available in different design versions.



ADVANTAGES

- Safe separation of two media in one heat exchanger; optimum transformer protection.
- Operation without risk for the overall process and/or environment; fast identification of leaks.
- No intermediate circuits needed.
- 100% flushed with heated transformer oil, particles monitored.
- 100% pressure tested on inner and outer tube side.
- Optimized corrosion protection for any application C3; C4; C5; Offshore

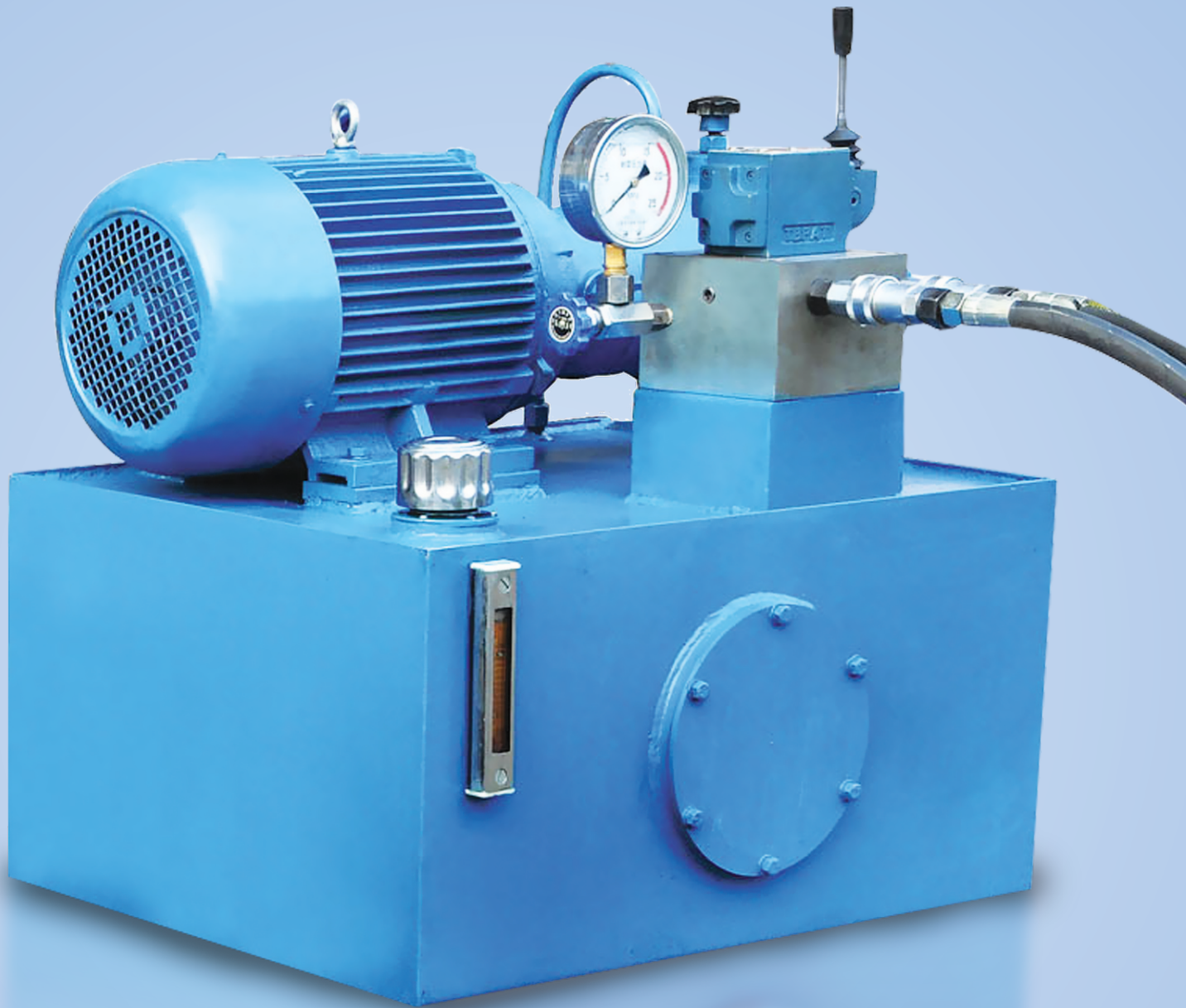

HYDRAULIC POWER

Lawatherm is one of the renowned suppliers of Hydraulic & Pneumatic Spares. We Provide Hydraulic Pump, Valve, Seal, Pipe, Cylinders, Power Pack, Automation Equipment and SPM.

Lawatherm holds in-depth stocks of a wide range of Hydraulic products including some of the best brands i.e. Dowty, Yuken, Polyhydron, Jacktech, Supremo, Rexroth, Vickers, Bosch are available with us in ready stock. We will give you the import substitute also in very competitive price.

We have a wide variety of Hydraulic Equipment, which have become benchmarks in the industry. Our quality controllers strictly check the range as per the standard quality parameters. We want to make sure that we can offer our clients highly efficient and durable range of hydraulic spares.



PIPE & V SEAL

Our pipe V seals are available in standard length and other measurements. All of these seals are qualitative in nature and are available in economical prices.



GEAR PUMP

Gear pumps (with external teeth) (fixed displacement) are simple and economical pumps. The swept volume or displacement of gear pumps for hydraulics will be between about 1 cm³ (0.001 litre) and 200 cm³ (0.2 litre). They have the lowest volumetric efficiency (approx 90%) of all three basic pump types (gear, vane and piston pumps). These pumps create pressure through the meshing of the gear teeth, which forces fluid around the gears to pressurize the outlet side. It's widely used on the industry machinery, mining machinery, loading transportation enterprises and agriculture machines.



DIRECTION / FLOW CONTROL VALVE

Control valves can also work with hydraulic actuators (also known as hydraulic pilots). These types of valves are also known as Automatic Control Valves. The hydraulic actuators will respond to changes of pressure or flow and will open / close the valve. Automatic Control Valves do not require an external power source, meaning that the fluid pressure is enough to open and close the valve. Automatic control valves include: pressure reducing valves, flow control valves, back-pressure sustaining valves, altitude valves, and relief valves. An altitude valve controls the level of a tank. The altitude valve will remain open while the tank is not full and it will close when the tanks reaches its maximum level. The opening and closing of the valve requires no external power source (electric, pneumatic, or man power), it is done automatically, hence its name.



HYDRAULIC CYLINDER

Lawatherm take this opportunity to introduce ourselves as manufacturers of Hydraulic power pack, Hydraulic/Pneumatic Cylinders, as per specific requirement of our valuable customers. We also undertake hydraulic system, up grading modifications for increased productivity.

Our manufacturing range of products includes:-
Custom Built Hydraulic & Pneumatic Cylinders

BORE DIA : 25MM to 600 MM
STROKE : 6000MM

MATERIAL SPECIFICATION

CYLINDER TUBES : ST 52.3 BK Grade Seamless Imported pre-honed Tubes.
PISTON RODS : HARD CHROME Plated Rods of CK grade
PISTON : C 45 Steel, Single Piece, Precisely Machined.
GLAND : Precisely machined steel Gland with Gun Metal Bushing.
MOUNTING : Accurately Machined Steel Suitable for Heavy duty Applications.
SEALIING SYSTEM : Importe Seals.

Temperature Instrument & Calibration

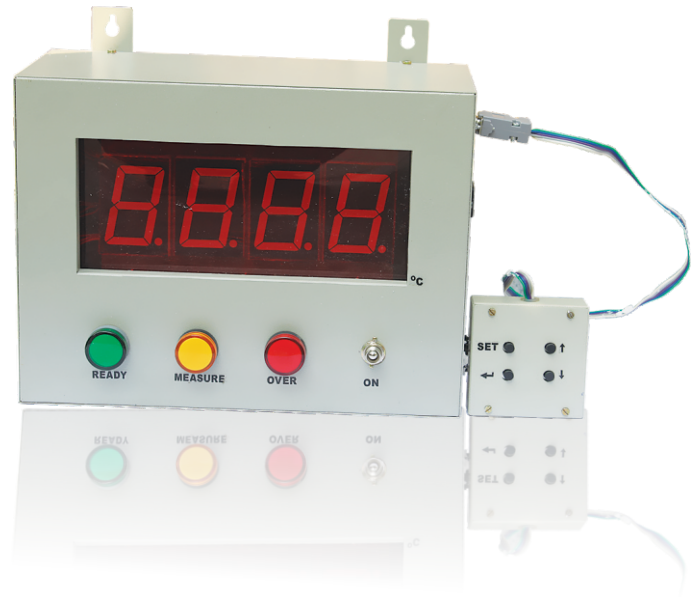

MOLTEN METAL TEMPERATURE INDICATOR

Today Lawatherm is a leading manufacturer of Microprocessor temperature measurement as well sensor, expandable thermocouple tips for molten metal temperature indicator both ferrous & non-ferrous & steel plants. We are focused to manufacture & supply best quality temperature measurement instrument related products. We are the pioneer in producing thermocouple tips, carbon cups, receptical and temperature measuring instruments for molten metal in a wide range as per industry requirement and customer's specification. We are well recognized in the industry for our best product offered at the best rate in minimum delivery period.

- Molten metal temperature indicator
- Expandable thermocouple tips
- Temperature Sensor
- Temperature Gauges (Thermometer)
- Temperature Switch (Thermostats)
- Digital Temperature Meter
- IR Temperature Gun
- Cables
- Thermocouple RDT's

TECHNICAL DATA

Model	OTS-1	OTS-2
Temperature Measuring Range	0°C to 1800°C	
Operating Temperature Range	0° to 50° C	
Temperature Detection Method	Flat Plateau	
Power Supply	230 V AC ± 10 V, 50 Hz	
Power Consumption	20 Watts	
T/C Element	Pt/Pt Rh 10%, 13%, 6/30%	
Accuracy ± 1° C	IPT5 68 or IPT5 48	
Calibration	Throughout the Range	
Housing Dust Proof M. S. Cabinet	3 to 5 Seconds	
Linearisation		
Response Time		
Display Size	1"	0.6"
Facility to connect LDU, AVP, Printer	Can be Connected	No Provision
Size in mm	305 x 165 x 350 (H)	215 x 95 x 295 (H)
Weight 7.1 Kg	3.1 Kg	
Output Signal (standard)	Serial Current Loop	-
Output Signal (on Request)	RS 232/BCD	-

Grab Buckets



LAWATHERM is a leading and well recognized name as Manufacturers proudly offers a comprehensive range of grab buckets, designed to meet the demanding needs of industrial material handling. Our grab buckets are engineered for efficiency, durability, and precision, making for well Sinking have good mechanism & specification from its base at Delhi.

Ventilation Products



AXIAL FLOW FAN

The Lawa Axial Flow Fan has been specially designed for removal of dust and fumes in work places where, due to long ducts, system-resistance is high and other conventional Exhaust Fans will not serve the purpose.

This aerodynamically efficient fan is available in diameters from 12" through 42", with direct drive capacities ranging to 29,000 cfm.

The Lawa Axial Fan housing is constructed of heavy duty welded steel and angle ring flanges, with a spark resistant, cast aluminum airfoil axial impeller.

The basic functions of ventilation and air conditioning are effectively performed by Axial Flow Fan, especially in industrial process system, crop drying, mines, foundries, steel plant, rolling mill, glass plant, power plant and other industrial facilities.

Lining Vibrator

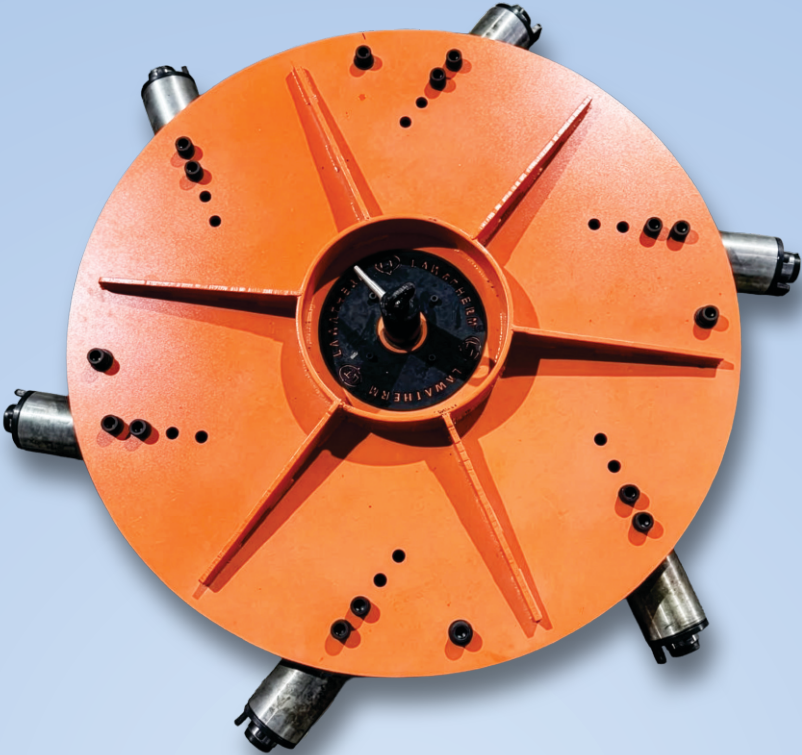

BASIC INTRODUCTION

In induction furnaces working face of the main crucible is lined with a suitable ramming mass. Furnace performance is directly related to the lining performance.

Well-stabilized lining results in smooth working of furnace, optimum output and better metallurgical control. The lining practice best suited to particular foundry will depend upon the furnace capacity and design, metal being melted and output etc.

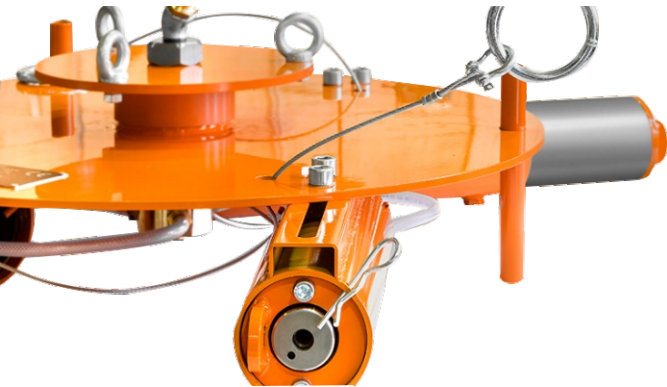

2/3/5/6 ARM LINING VIBRATOR

2/3/5/6 arm lining vibrators are used for side lining preparation, consist 2/3/5/6 vibrator cylinder and one air divider at center of the equipment. It automatically rotates inside the former due to the angle of impact. It will take 1-2 hours for the full operation.



VIBRATOR

2/3/5/6 Arm Vibrator

LT01	300-500 Kg	2 Arm Vibrator
LT02	500 Kg-2T	2 Arm Vibrator
LT03	3T-6T	3 Arm Vibrator
LT04	7T-10T	3 Arm Vibrator
LT05	12T-15T	3 Arm Vibrator
LT06	20-25T	5 Arm Vibrator
LT07	28-30T	6 Arm Vibrator
LT08	40T	6 Arm Vibrator

BOTTOM LINING VIBRATOR

Bottom Vibrator Unit ramming plate is equipped with one pneumatic vibrator. Dry refractory is rammed in about 50min. in one operation, achieving perfect compaction and absolutely even and leveled bottom.



Air Demolition Hammer

Lining Vibrator

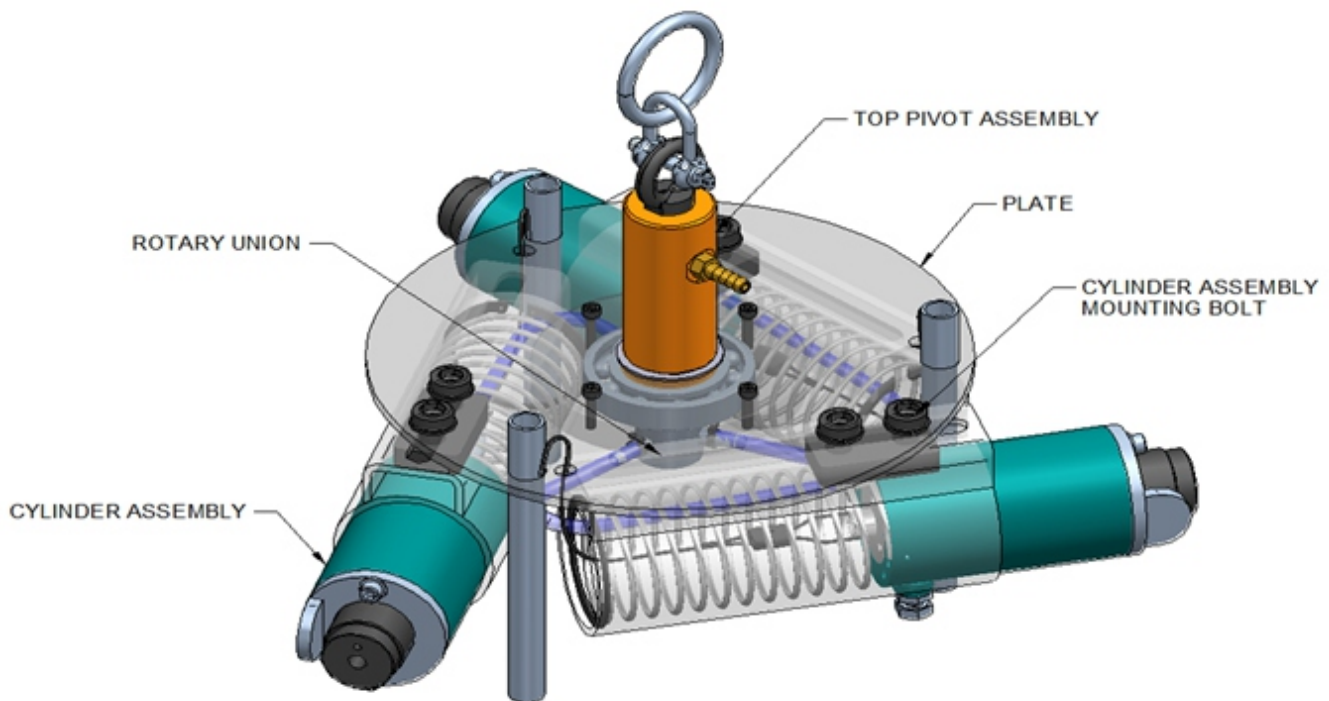

Basic Introduction

In induction furnaces working face of the main crucible is lined with a suitable ramming mass. Furnace performance is directly related to the lining performance. Well-stabilized lining results in smooth working of furnace, optimum output and better metallurgical control. The lining practice best suited to particular foundry will depend upon the furnace capacity and design, metal being melted and output etc.

Requirement Of A Proper Lining:

- Thermal characteristics: it should withstand the stresses developed by the thermal cycle in operation.
- It should be chemically inert to the metal being melted: chemical inertness to molten metal can be achieved by using acid lining for acid slag & basic lining for basic slag.
- It should have enough structural strength to withstand operating conditions.
- The thickness of refractory lining must be such as to ensure good electrical efficiency and thick enough to counter the risk of unexpected failure and major damage to the coil.
- It should have high erosion resistance.
- It should have low thermal & electrical conductivity.
- It should have proper hardening characteristic.
- It should have easy installation procedure.
- It should be easily repairable, economical & possess ease of knocking/removal.

Comparison Manual Lining V/s Lining Using Vibrator



S.No	Manual Lining	Lining Using Lining Vibrator
1.	Erratic and shorter lining life	Consistent and enhanced lining life
2.	Unpredictable production	Predictable and increased total output tonnage
3.	Density of Lining is not uniform	Density of lining is uniform throughout the shell.
4.	Lining thickness is not uniform around the former	Lining thickness is absolutely uniform around the former
5.	Refractory material in the tapered Section of the former is not completely deaerated leading to non-uniform erosion of lining and problems like elephant foot & leakage	Material in the tapered section of the former is completely dense achieving max. & uniform compaction. Thus erosion is uniform in the tapered section eliminating any possibility of elephant foot & leakage due to weak lining.
6.	Refractory material in the tapered Section of the former is not completely deaerated leading to non-uniform erosion of lining and problems like elephant foot & leakage	Material in the tapered section of the former is completely dense achieving max. & uniform compaction. Thus erosion is uniform in the tapered section eliminating any possibility of elephant foot & leakage due to weak lining.
7.	Labor Intensive	One skilled and one semi-skilled person can perform the whole lining
8.	Lots of hazardous silica & dust in the air	Pollution free
9.	Takes long hours to line the furnace from start to finish	Whole process of lining is completed in 3-4 hours
10.	Hassles due to human component like attitude, error & fatigue.	Smooth and hassle free operation

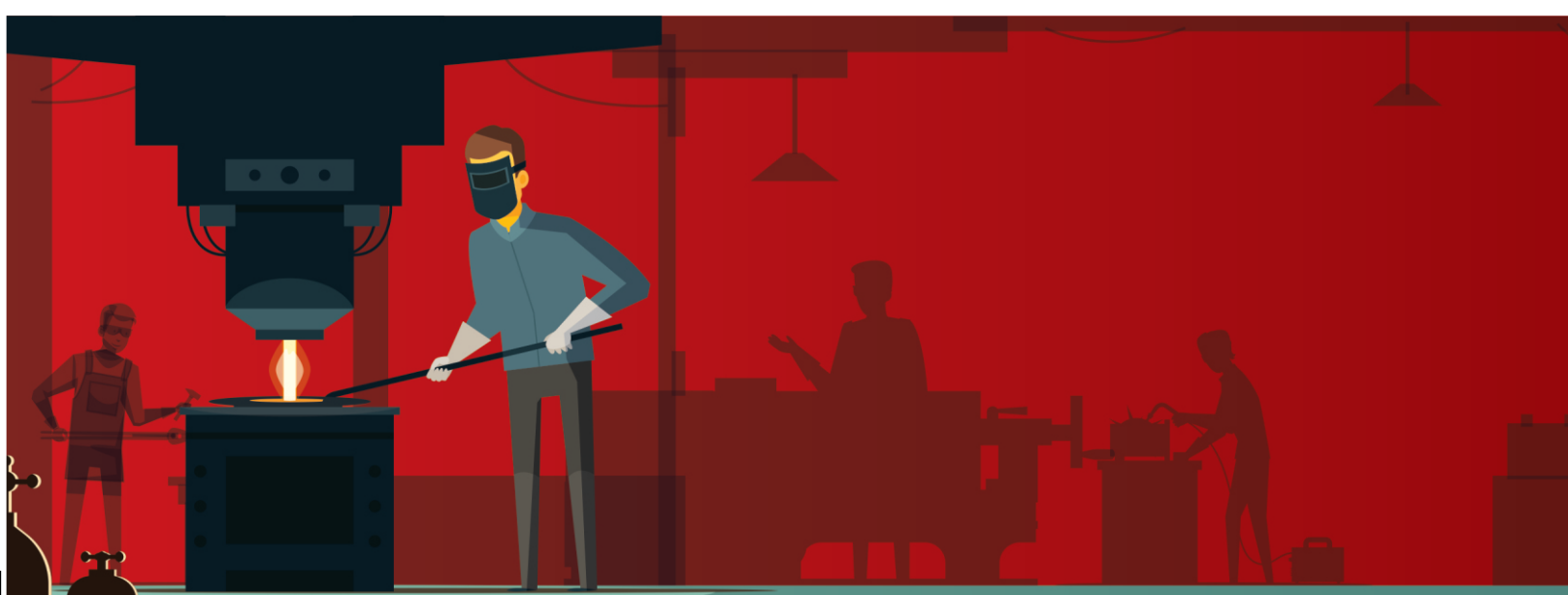

Basic Lining Procedure

Bottom Lining

- Pour the ramming mass in the bottom to the extent and level the ramming mass.
- Start the ramming with bottom lining vibrator. Continue ramming till layer becomes hard. Keep on introducing layers of proper thickness and repeat the process till required level is attained.
- Care has to be exercised not to allow antenna rod to bend during bottom lining installation.

Side Wall Lining

- Make sure that furnace bottom is leveled.
- Lower the former into furnace making sure it sits flat and level on bottom refractory. Check the surface of former makes contact with earth leakage antenna.
- Set the former in place and position so that the resulting wall thickness will be consistent and concentric with coil.
- After aligning former, introduce ramming mass in the space between former and coil. Now compact it with 3 Arm lining vibrator till it becomes hard.
- Keep on adding ramming mass during 3 Arm lining vibrator movement from down to up.
- After reaching to top layer make the top collar and spout with ramming mass ix with sodium silicate.



3 Arm Lining Vibrator

3 arm lining vibrators are used for side lining preparation, consist 3 vibrator cylinder and one air divider at center of the equipment. It automatically rotates inside the former due to the angle of impact. It will take 1-2 hours for the full operation. There is require 6kg/cm² Air pressure for smooth operation during the lining

Bottom Lining Vibrator-

Bottom Vibrator Unit ramming plate is equipped with one Electric vibrator. Dry refractory is rammed in about 40 min. in one operation, achieving perfect compaction and absolutely even and leveled bottom.

Salient Features

- Lining vibrator is equipped with a control panel by which we can select the vibrator to operate in AUTO MODE.
- Control panel controls the timing and lift of the vibrator through the hoist.
- Contact between former & vibrator is controlled & consistent during vibration
- 3 arm lining vibrator can adjust itself against the taper of the former.

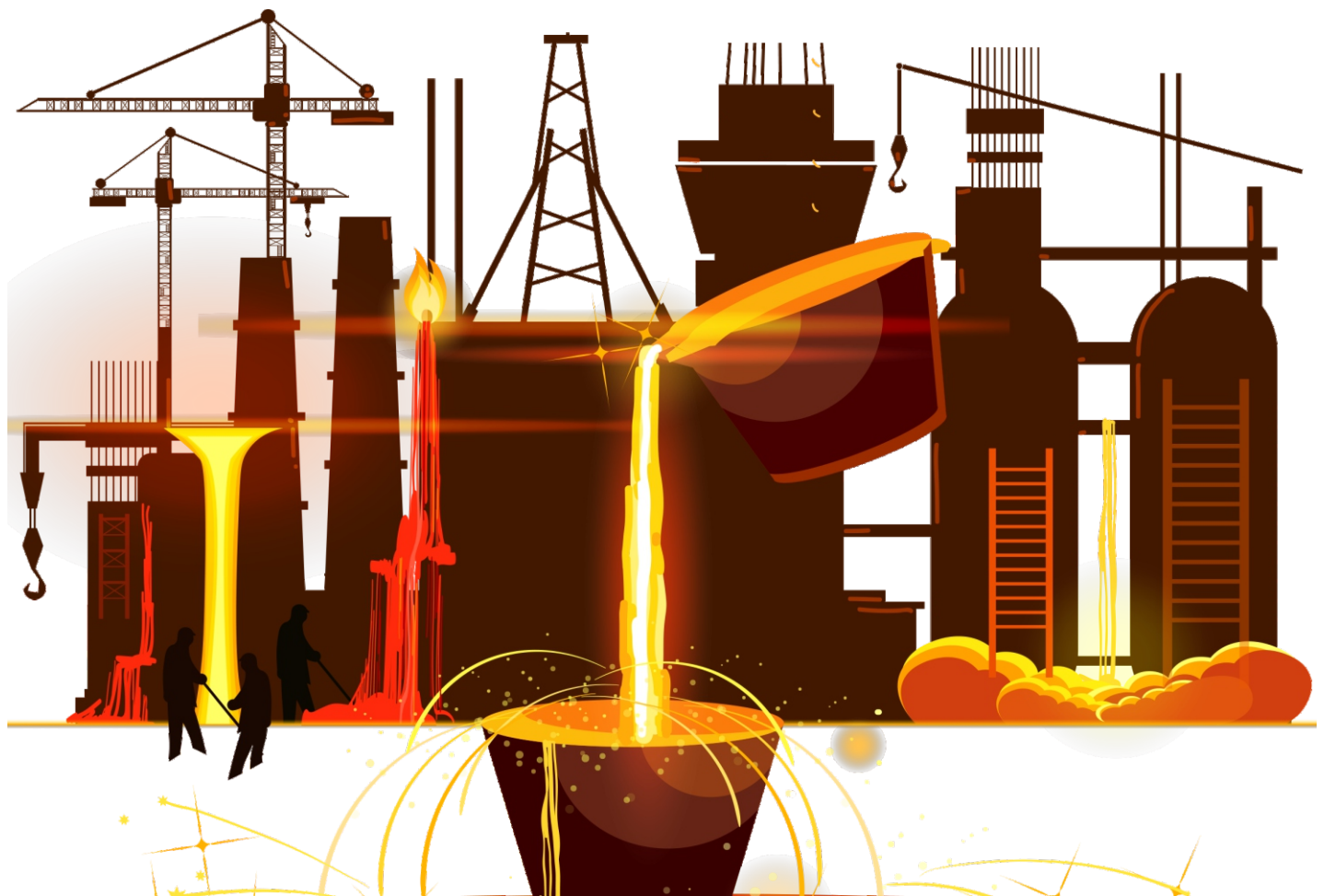

Sintering Pre-heater

Lawatherm manufactures state-of-the art Pre-Heaters for furnace and the ladle and supplies its systems across India and abroad. Our pre-heaters are custom designed as per the need of the consumer.

SINTERING PRE-HEATER FOR FURNACE

- Pre-heating the furnace reduces its energy requirement for melting and thus increases the efficiency of the melting process in sintering heat cycle.
- Lawatherm customized sintering pre-heaters for furnace can be used for a capacity of 6-30 Ton, heating the furnace up to 600 degree Celsius within 180 minutes.
- The Nichrome strip used as the heating element can sustain high temperature effortlessly.
- Provides safer work environment during melting process. Enhances longevity of the furnace.
- The initial set up cost is significantly low compared to any other pre-heating systems available in the market.
- The process minimises carbon emission and thus helps reducing pollution.
- Pre-Heating the furnace improves the melting rate by maximum 15%.
- Helps increasing productivity significantly.
- Temperature measurement and control is automated and the pre-heater is fitted with a digital temperature indicator.
- Lawatherm furnace pre-heating systems are flexible and removable. A single pre-heater can be used for different furnaces of similar capacity at the same shop floor.



VARIOUS TYPES OF FURNACE PRE-HEATERS:

COLD SINTERING PRE-HEATERS:

- Less preheating time • Moderate soaking time • Cost effective

Sr. No.	FURNACE CAPACITY (TON)	REQUIRED POWER (KW)	PREHEATING TIME (MINUTE)	PREHEATING TEMP (DEG C)
1	6	80	150-180	350-400
2	8	90	150-180	350-400
3	10	90	150-180	350-400
4	12	100	150-180	350-400
5	15	100	150-180	350-400
6	20	125	150-180	350-400
7	25	135	150-180	350-400
8	30	180	150-180	350-400

Hot Sintering pre-heater:

- Moderate pre-heating time • Less sintering time • Possible to go to full power in short time
- Effective for synchronizing melting

Sr. No.	FURNACE CAPACITY (TON)	REQUIRED POWER (KW)	PREHEATING TIME (MINUTE)	PREHEATING TEMP (DEG C)
1	6	100	180-200	500-550
2	8	100	180-200	500-550
3	10	110	180-200	500-550
4	12	125	180-200	500-550
5	15	135	180-200	500-550
6	20	150	180-200	500-550
7	25	180	180-200	500-550
8	30	200	180-200	500-550

SINTERING PRE-HEATER FOR FURNACE

- Ladle is pre-heated to remove moisture from the inner-lining and it betters the lining life.
- Lawatherm sintering pre-heaters come in different sizes and capacities- serving ladles from 6-30 Tons and can be heated up to 450 degree Celsius for heating around 200 minutes.
- It helps reducing the cycle time and thus increases efficiency of the process.
- Our pre-heating system uses Nichrome strip as the heating element, hence easily sustain high temperature.
- The process is smokeless and less polluting.
- The Ladle is covered and there is minimum heat loss. The system is energy efficient and saves cost.
- The set-up is flexible and one set up can be used in more than one ladles (of similar capacity) in the same plant.
- Heating control is automated and the heater is fitted with a digital temperature indicator.
- Ensures safety of the worker.

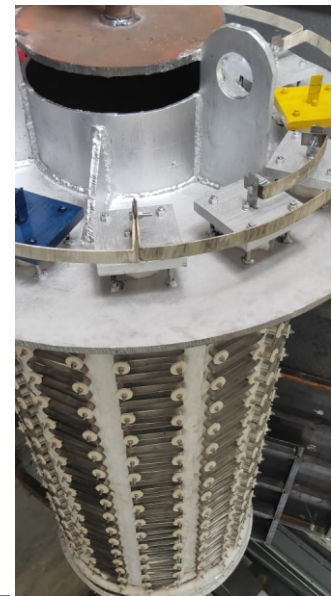

VARIOUS TYPES OF LADLE PRE-HEATERS

Sr. No.	FURNACE CAPACITY (TON)	REQUIRED POWER (KW)	PREHEATING TIME (MINUTE)	PREHEATING TEMP (DEG C)
1	6	110	180-200	400-450
2	8	110	180-200	400-450
3	10	120	180-200	400-450
4	12	135	180-200	400-450
5	15	145	180-200	400-450
6	20	160	180-200	400-450
7	25	190	180-200	400-450
8	30	225	180-200	400-450



DM Water Circulation System

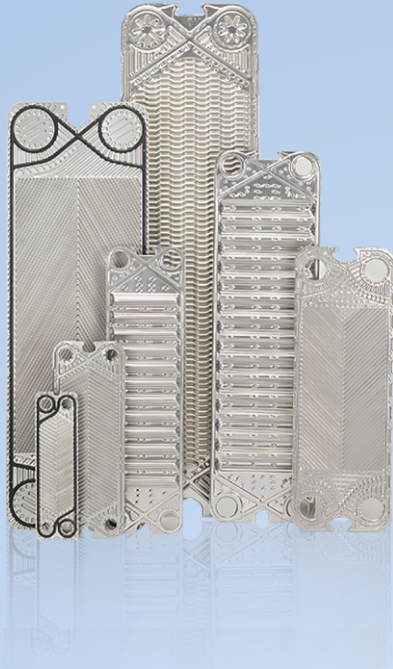

PLATE HEAT EXCHANGER

Lawatherm specializes in after-market and genuine spare parts for separator equipment (plate heat exchanger) & liquid processing pump (stainless steel centrifuge pump). We are one of the largest and truly independent suppliers of the major OEM's and aftermarket spare parts and service for Alfa Laval, GEA Eco-flex, Tranter, HRS heat exchanger, SWEP and others.

In addition Lawatherm is committed to providing the largest selection of spare parts in the industry we also offer a broad range of high quality, genuine gaskets, pump seal, which come with all the same guarantees as their branded counterparts, together with complementary accessories. We are continuously increasing our inventory to meet the demands of our customers. All spare parts whether genuine or equivalent are fully compatible.

Lawatherm are able to source and supply spare parts worldwide. Combined with an extensive stock holding, enables us to keep prices competitive and keep lead times to a minimum. We supply a wide range of process components for various applications with in steel melting, food beverage and chemicals processing industries.

"From a seal ring to a complete centrifuge system, Separator Spares Lawatherm can provide solutions for all your separation and spare parts needs."

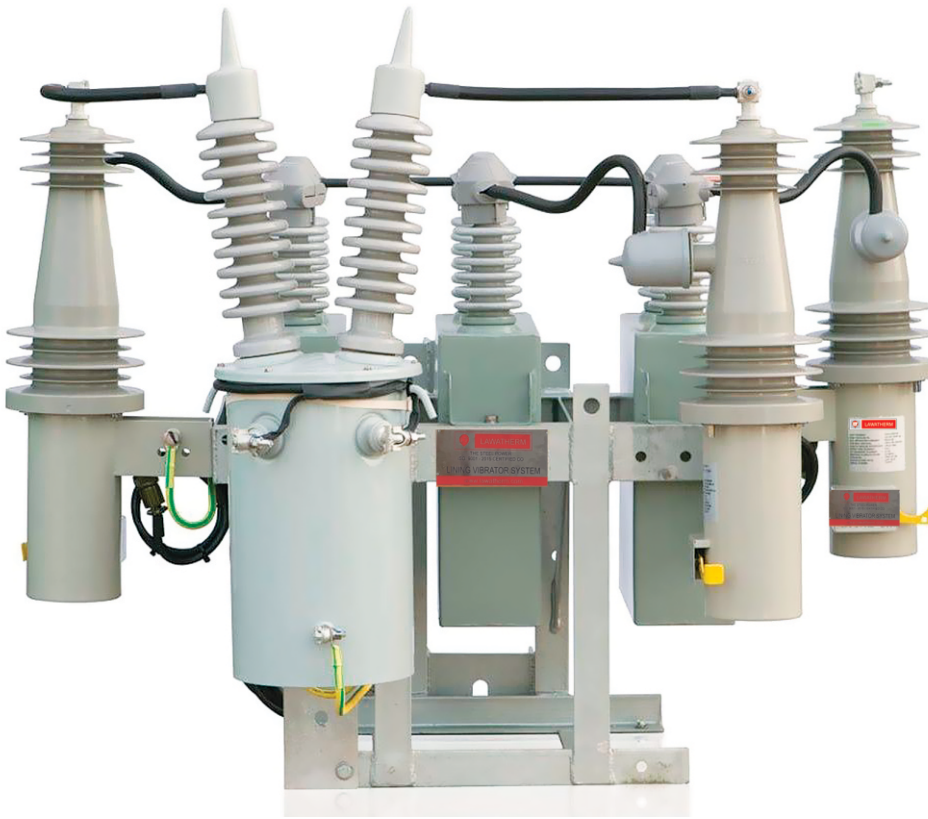

HV CAPACITORS BANK

General Information: The active power produced by active current can alone be tuned into an effective use for the consumer, while the reactive power produced by the reactive current does not yield usable power and consequently is not registered on the active performance meter. The reactive power has negative effect on the generator, transformer conductor lines, inductive heating and motor chokes while causing voltage drop and fiscal losses due to additional electric heating. The reactive power required for the creation of the magnetic field round motor, transform continuously oscillates between current generator and consumers. The more cost effective way to provide the reactive power is to produce is by placing ABB capacitor close to the consumer of reactive power [Motor/Trasformers].

Thus, relieving the line between generator and consumer of the transport for the reactive portion. This way several more current consumers can be connected to a existing supply system without having to extend or amplify that system if the capacitor are suitably positioned. Enhancing power quality improvement of Power Factor saves cost and ensures fast return on investment.

Features

All film dielectric is used and consist of polypropylene in the form of biaxially oriented film, hazy on both sides, and in two or three layers with lasercutaluminium foil for the electrodes.

The Capacitors are impregnated with a NON-PCB base fluid.

Dielectric Loss approx. 0.1 W/KVAR

ABB Capacitors are designed, manufactured and tested to meet the requirments of IS13925-1994, IEC-60871, Voltage Range- 22KV-24KV

Frequency – 50 Hz /60 Hz

Corrosion Protection

Maximum Permissible Current [Capacitors units shall be switched for continuous operation at an RMS current of 1.30 times the current that occurs at rated sinusoidal voltage and rated frequency, excluding transients].

Temp range: 5°C – 55°C

Decreasing Voltage drop

Application

8 Individual PF Correction

individual PF Correction on three phase motor

Individual PF Correction of power Transformers

Individual PF Correction of group power factor correction

Central Power Factor Correction of all industrial /Inductive Loads



Lawatherm is known for providing most appropriate material handling (EOT Crane) spare solutions to various industry segments. Lawatherm lifting equipment is operating in the most demanding industries and environments including steel and other primary metals, wood yards, petrochemical and mining, as well as ports, shipyards and intermodal terminals. We know cranes and machine tools and apply that knowledge in our supply of parts. Our spare part services cover any brand of crane and hoist, other lifting equipment or machine tools. Lawatherm technicians understand what it takes to keep your equipment working at top performance. We train our service team to understand the unique requirements of each installed brand and provide the appropriate services in accordance with original equipment manufacturer (OEM) specifications.

Our products are designed, based on the respective Indian standards and hence can be interchanged with other brands provided of course if the other manufacturer has also followed the correct Indian standards while designing and manufacturer his products. Also in our company we have an ongoing process of R&D for improving the quality for our products.

Since we are regularly manufacturing the products at times we can even supply material at short notice there by reducing the down time of the customer's system during maintenance or breakdown.

As a Leading the Indian overhead crane spare industry with the largest service network and a complete range of lifting equipment,

- Automotive
- Energy From Waste
- Intermodal and Rail
- Manufacturing
- Mining
- Nuclea
- Petrochemical
- Ports
- Power
- Pulp & Paper
- Shipyards
- Steel

In addition to the complete range of control gear equipment and keeping with our commitment to provide our customers with the best possible services, we also supply shrouded bus bar conductors as well as radio remote controls, so that our factory where we have a single outlet ,we can provide our customer be it a crane manufacturer or crane uses this unique service.



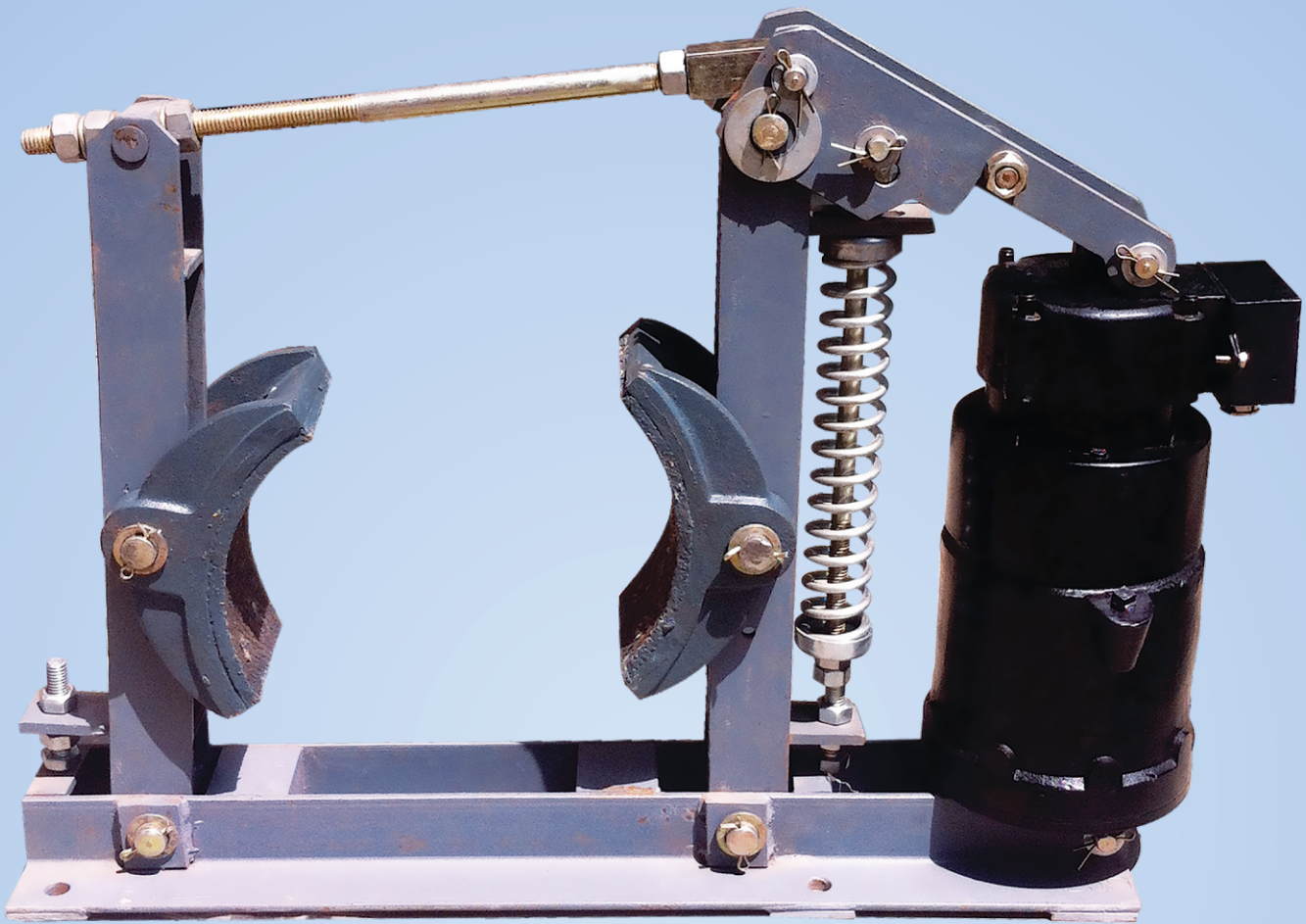

ELECTRO HYDRAULIC THRUSTOR BRAKES

Introduction

Lawa Thruster brake is a device to retard the speed of moving machinery and to stop it accurately to the desired position. The braking force is applied to the brake shoes by a pre-stressed compression spring. The shoes press on the rotating brake drum retarding its speed, and finally stopping it. The releasing of the brake and compressing of the spring is done by thruster. Other release devices like pneumatic cylinder or manual release arrangements can be offered on request.

Construction And Operation

Thruster brake has a pair of cast iron shoes which are lined up with friction pads. The shoes are hinged on main arm and side arm of the brake. Each of them have a hinge pin fitted in the base. They are connected to each other on top by a tie rod, which is hinged in the main arm and locked to the swivel block in the side arm, by a lock nut.

A crank lever is hinged on the main arm, and the other end is fixed to the top clevis of the thruster by a hinge pin. A brake spring, is fixed on the main arm and is pre-loaded by a locknut on the lever, pre-tension in this spring decides the breaking torque. The thruster is fitted on the base by a hinge pin. When the thruster is not energized, the brake shoes are pressed on the brake drum fitted on the drive motor shaft and hold it under the effect of braking force provided by the spring. In such condition, the brake is applied, and the drum cannot rotate. When the thruster motor is energized, the thrust provided by the thruster lifts up the crank lever which move the arms and the shoes away from the brake drum, there by releasing the braking force. The spring is compressed and braking energy is stored for the next cycle.

FOUNDATION

To install the brake, the foundation must be made ready with tapped holes of proper size as per the dimensions mentioned in the dimension table. Care must be taken to ensure the center line of the brake coincides with the centerline of the brake drum and also the level of mounting pads "h" is matching with the center height of the brake drum.

INSTALLING BRAKE IN POSITION

To insert the brake in position the brake shoes are to be taken apart to clear the drum diameter. To do this, slacken the setting bolts and the tie-rod nuts in the side arm pull it slightly. This will increase the distance between the brake shoes and the brake can now be inserted on the foundation bolts and the shoes can be positioned on the brake drum. Re-tighten the setting bolt and the tie-rod nuts. Tighten the mounting bolts.

INSTALLING THRUSTER ON BRAKE

The thruster to be filled with sufficient quantity of oil as mentioned in the Thruster Table. To mount the thruster on the brake, remove one side split pins on the thruster hinge pins of the brake and the lever. Remove both pins and re-insert them after positioning the thruster on the pin holes in the base and lever of the brake, replace both split pins, check that the thruster movement is unobstructed when the crank lever is pulled manually and the thrust rod of the thruster and connect 3-phase, 415 Volts power supply cables to the three terminals on the terminal plate inside the terminal box. Terminate the earthing lead on the earth terminal provided on the thruster or brake. Replace the terminal box cover on the terminal box. The thruster is ready for operation.

ALIGNING AND SETTING OF BRAKE

Next, align the brake shoes with the diameter and surface of the brake drum and adjust the nuts on the tie-rod such that both shoes grip the brake drum equally. Energize the power cables. This will cause the thrust rod of the thruster to move up and the brake is released as the shoes released the brake drum. Adjust the gap between the drum and shoes to 0.3 to 0.5, equally by adjusting the setting bolts on both arms. For equal and uniform liner wear it is necessary to ensure that the shoes and the arms move equally. This is done automatically by the ball on one arm and a matching vee on the other arm.

TECHNICAL DATA :

Diameter	Braking Torque
100 mm (4") x 18 kg	06 kgm
150 mm (6") x 18 kg	09 kgm
160 mm (6") x 18 kg	09 kgm
200 mm (8") x 18 kg	020 kgm
200 mm (8") x 34 kg	032 kgm
250 mm (10") x 18 kg	035 kgm
250 mm (10") x 34 kg	042 kgm
300 mm (12") x 18 kg	042 kgm
300 mm (12") x 34 kg	062 kgm
400 mm (16") x 34 kg	090 kgm
400 mm (16") x 68 kg	170 kgm
500 mm (20") x 46 kg	190 kgm
500 mm (20") x 68 kg	290 kgm
600 mm (24") x 114 kg	580 kgm

ELECTRO HYDRAULIC THRUSTORS (ST)

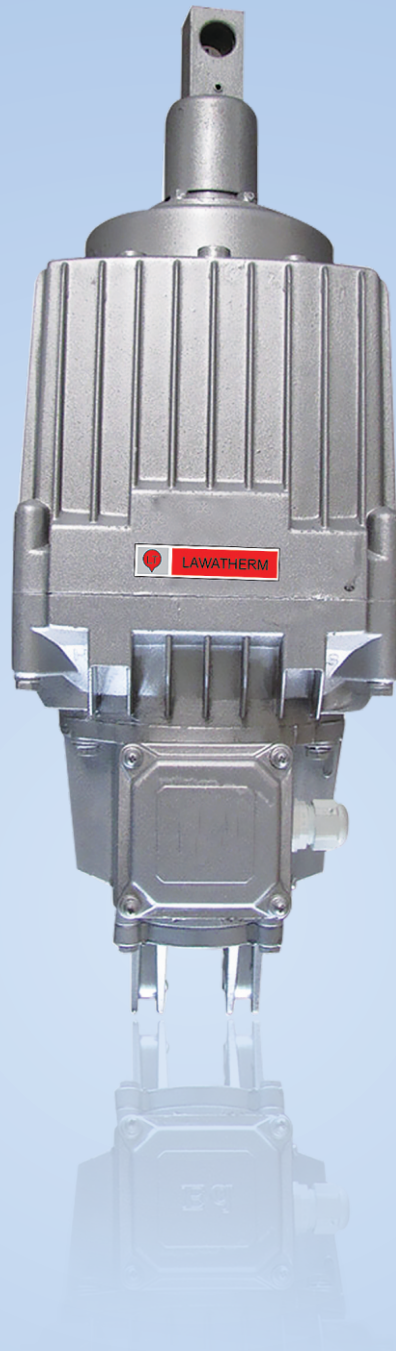

ELECTRICAL SUPPLY

Unless otherwise specified, all thrusters are suitable for operation for 415 Volts, 3-phase, 50 Hz power supply. Thrusters for other voltages up to 600 VAC, 3-phase can be supplied against specific enquiries.

Connections

Lawatherm Thrusters operated equally well in both directions of rotation. Therefore, the three phase supply lines can be connected the Thrusters in any R-Y-B phase sequence. Provide adequate safety backups.

Oil Requirements

Thrusters are supplied without oil to avoid spillage during transportation. They must be filled with sufficient quantity of oil before installation. For all models of thrusters, it is recommended to use Transformer Oil as specified in BS : 148. Oil capacity requirements are listed in the table below.

Installation Of Thrusters

Lawatherm Thrusters are suitable for vertical mounting only. After filling the thruster with required quantity of oil. Install it by using the clevis and hinge pins provided. Insert the locking spilt pins. Ensure that no excessive transverse forces are acting on the thrust rod. Wipe out the dust, paint or oil deposits from the operating section of the thrust rod pins by dry and clean cloth.

MAINTENANCE

Lawatherm Thrusters is designed for long trouble free service. The motor windings are designed to meet contingencies. The bearings are adequately sized.

Routine maintenance schedule includes checking the oil level and topping them if necessary. If oil contamination is detected, drain it out completely and refill with fresh oil. Check and correct the oil leakage if detected.

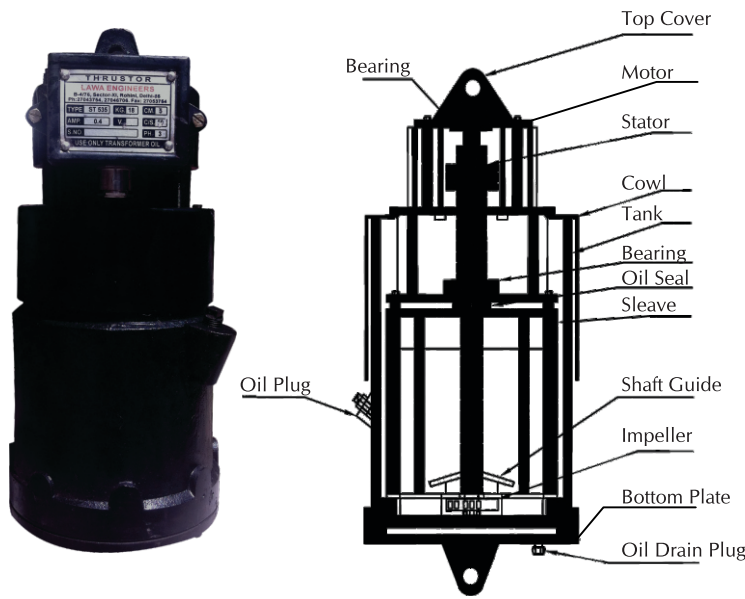

THRUSTOR ST-520

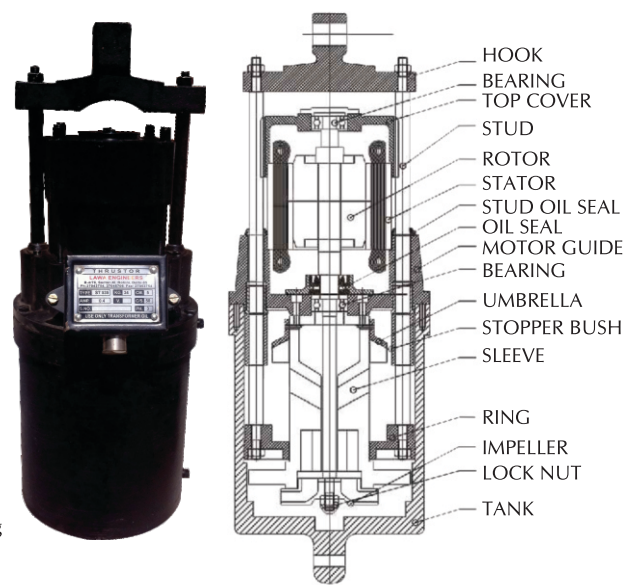

THRUSTOR ST-535

Dimensions																			
Type	Rated Thrust kgs. (N)	Output Stroke mm.	Input watts	A	B	C	D	E	F	G	H	J	K	L	M	P	Q	wt. (kg.)	Oil Capacity liters
ST 520	18 (180)	51	90	349	51	159	19	25	13	12.7	19	16	19	32	19	110	90	14	2.0
ST 535	34 (340)		150	444		171	22	29	14	19.7		21	27	41	25	138	118	30	2.5
ST 545	45 (450)		180																
ST 870	68 (680)	76	200	508	76	216	25	32	16	22.2	25	24	29	48	32	152	132	40	4.5
ST 8110	114 (1140)		250																
ST 13200	225 (2250)	127	420	660	127	254	32	38	19	25.4	30	27	45	54	38	152	132	55	9.0
ST 13300	295 (2950)		580																

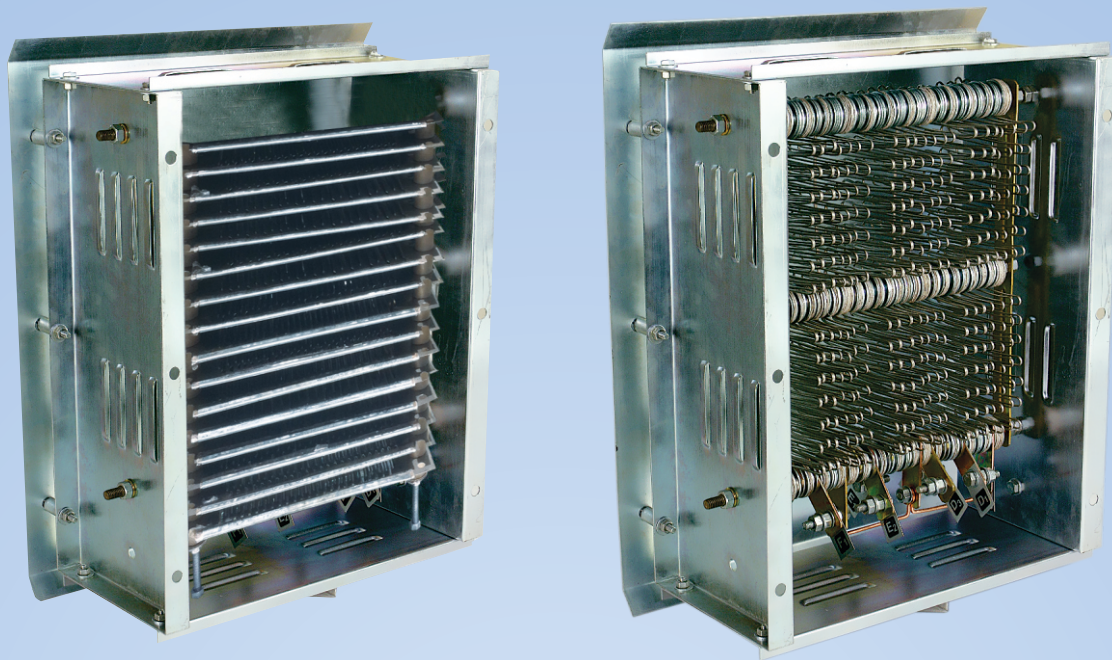

WIRE GRID & PUNCH GRID

Introduction

Lawtherm Resistance boxes are used to add resistance in an electric motor circuit for modifying the performance characteristic of Slip Ring Electric Motors of EOT Cranes, Rubber Mills, Steel Rolling Mills, Cement Plants, Power Plants, Conveyors, Coke Oven, Blowers etc. for speed control and developing starting torque with low starting currents. They are also used as Dynamic Breaking Resistor for V.V.V.F.A.C. Drives, electric loading of AC Altimeters, DC Generators and Dynamometers.

Resistors are designed to meet requirements of both A.C. & D.C. Application.

Type Of Resistors

The basic type of resistors are:

1. Stainless steel Wire Grid Resistors
2. Stainless Steel Punched Grid Resistors
3. Feccal Punched Grid Resistors

Current Ratings

Resistors are manufactured for current ratings from 10 to 800 Amps. Continuous duty resistors of higher ratings are made by using two-or more parallel paths. Resistors with short time rating up to 3000 Amps (or even higher), for neutral earthing are possible for system voltage up to and above 11KV.

Stainless Steel Wire Grid Resistors

These resistors consist of stainless steel wires or strip in form of grids. The current rating generally range from 7 Amps to 100 Amps. For continuous duty applications with single or multiple paths.

Stainless Steel Grid Resistors

Punched steel grid resistors consist of grid punched from corrosion resisting nickel chromium alloy sheet steels. The punched steel grids are completely immune to shock & vibration. They function reliably under the worst operating conditions and are particularly suited for steel mill duty. These resistors are available in wide range of current ratings from 8 Amps to 800 Amps for continuous duty with single or multiple parallel paths.

Features

- | | |
|---------------------------------|------------------------------------|
| 1. Enclosure material | - Galvanized Sheet Steel (Hot dip) |
| 2. Mounting | - Floor mounting |
| 3. Degree of protection | - IP-21/22/23. |
| 4. Current Rating (SS W - Grid) | - 7 to 100 Amps Continues. |
| 5. Current Rating (SS P - Grid) | - 7 to 800 Amps, Continues. |
| 6. Cooling | - Air Cooled |
| 7. Temperature rise | - 225°/250°/375°C |
| 8. Cable Entry | - Bottom |

DIMENSION DETAILS OF RESISTANCE BOXES

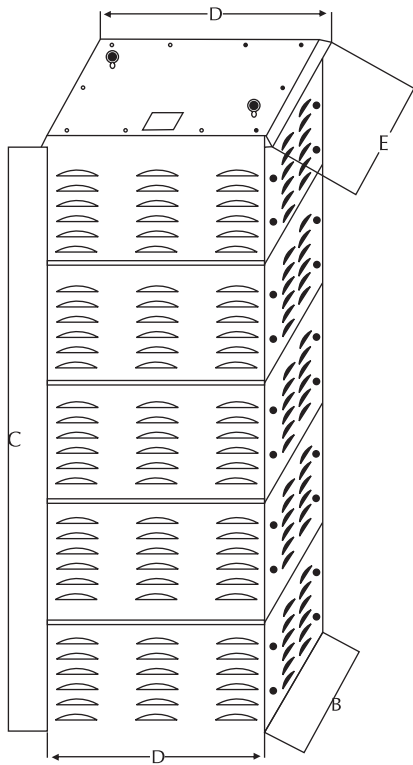

SS WIRE GRID TYPE
ALL DIMENSIONS ARE IN MM

Type	Length (A)	Width (B)	Height (C)	Top Cover (D)	(E)
1 S-380	380	460	210	600	600
2 S-380	380	460	390	600	600
1L	600	460	210	760	630
2L	600	460	390	760	630
3L	600	460	570	760	630
4L	600	460	750	760	630
5L	600	460	930	760	630

SS PUNCHED GRID TYPE

Type	Length (A)	Width (B)	Height (C)	Top Cover (D)	(E)
1 S	530	530	320	600	600
2 S	530	530	600	600	600
1L	680	530	320	760	630
2L	680	530	600	760	630
3L	680	530	880	760	630
4L	630	530	1160	760	630
5L	630	530	1440	760	630
1L-830	830	530	320	900	630
2L-830	830	530	600	900	630
3L-830	830	530	880	900	630
4L-830	830	530	1160	900	630
5L-830	830	530	1440	900	630
1L	1160	530	320	1250	645
2L	1160	530	600	1250	645
3L	1160	530	880	1250	645
4L	1160	530	1160	1250	645
5L	1160	530	1140	1250	645

In case of 3 Steps the no. of connections shall be 9 nos where as in case of 4 Steps the no. of connections shall be 12 nos

DIMENSION DETAILS OF PUNCHED GRID TYPE RESISTANCE BOXES

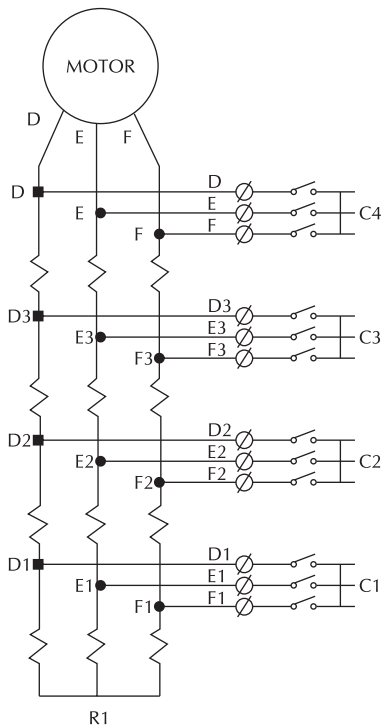

C1 - C4 = RESISTANCE CONTACTOR
R1 = RESISTANCE BOX
D - F3 = TERMINALS OF RESISTANCE BOX

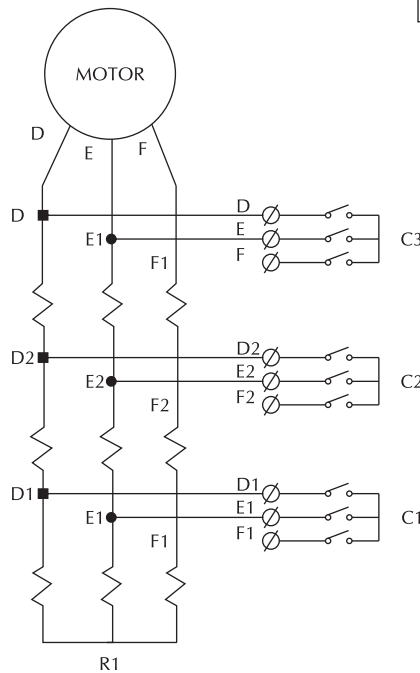

C1 - C3 = RESISTANCE CONTACTOR
R1 = RESISTANCE BOX
D - F2 = TERMINALS OF RESISTANCE BOX

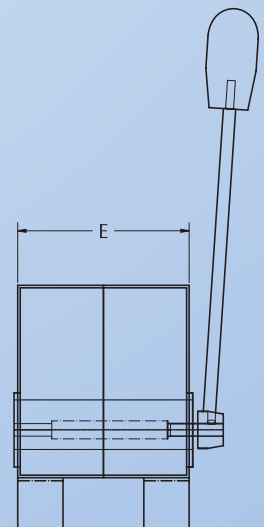
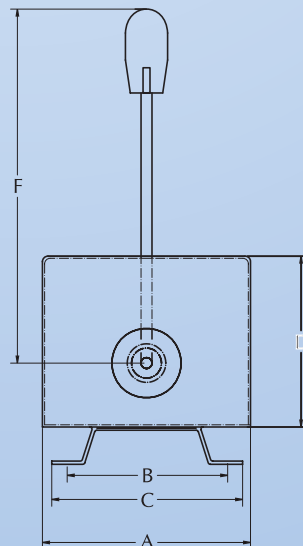
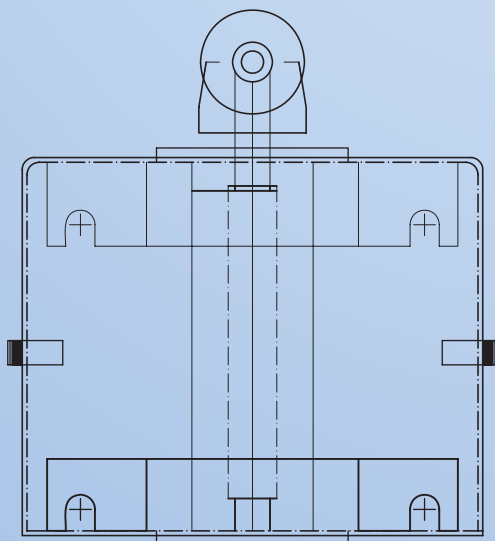

MASTER/CAM CONTROLLERS

Introduction

Lawatherm Master Controllers are used for remote operation of Contactors in equipment such as E.O.T. Cranes & Rolling mills drives. The Controllers are made in dust proof enclosure in IP-41 degree of protection, up to 6 notches either side with maximum 24 contacts as per desired sequence.

Spring return arrangement & Dead man's handle arrangement are also available.

General

Master Controllers are of cam type where in contacts are actuated by individual cams mounted on operated shaft.

The Shaft are cut accordingly to the type of sequence required by the customers.

For this a blank sequence diagram can be provided by us to be filled in by the customers.

Construction

Master Controller is housed in enclosure and provided with an easily removable cover with ample area for maintenance.

The cam shaft is mounted on bearing bushes on walls of housing.

The cams are made of delrin material and fixed on square.

Technical Data:

Body Material	- Sheet Steel (POWDER COATED)
Protection Degree	- IP-41
Confirming to IS	- 13947 (Part-1) 1993
Mounting Position	- Horizontal / Vertical
Contact Material	- Silver Cadmium
Rated Voltage Insulation	- 500 V. A.C
Thermal Test Current	- 10 Amps.
Cable entries	- 2x20Ø 2x2Ø standard conduit
Frequency of operation	- 1000 switching per hour
No. of contacts	- 24 maximum
No. of steps	- 6-0-6 maximum
Optional	- Spring return / Deadman's Handle arrangement

A	B	C	D	E	F
FOR 1/2, 1/3, 3/5, 4/6, 4/7, 4/8,					
190	127	154	155	136	250
FOR 4/10, 4/12, 5/8, 5/10, 5/12, 5/13					
190	128	154	155	198	

ROTARY GEARED LIMIT SWITCHES

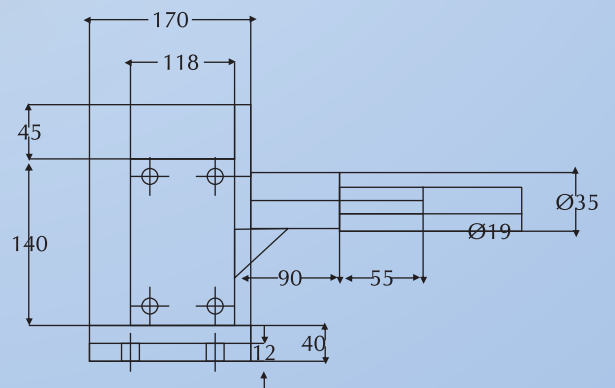
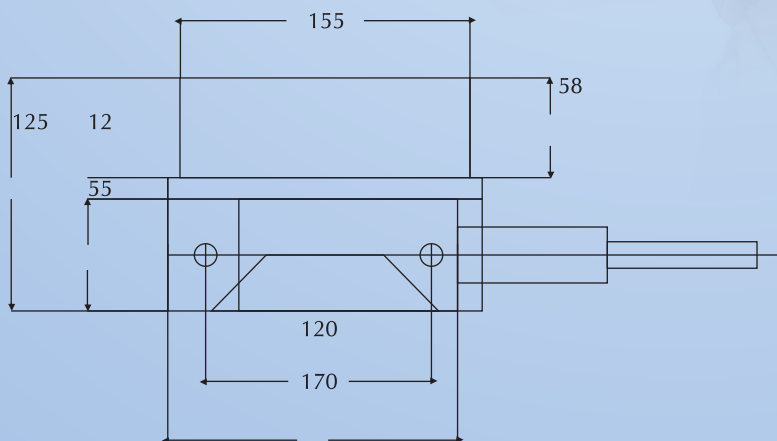
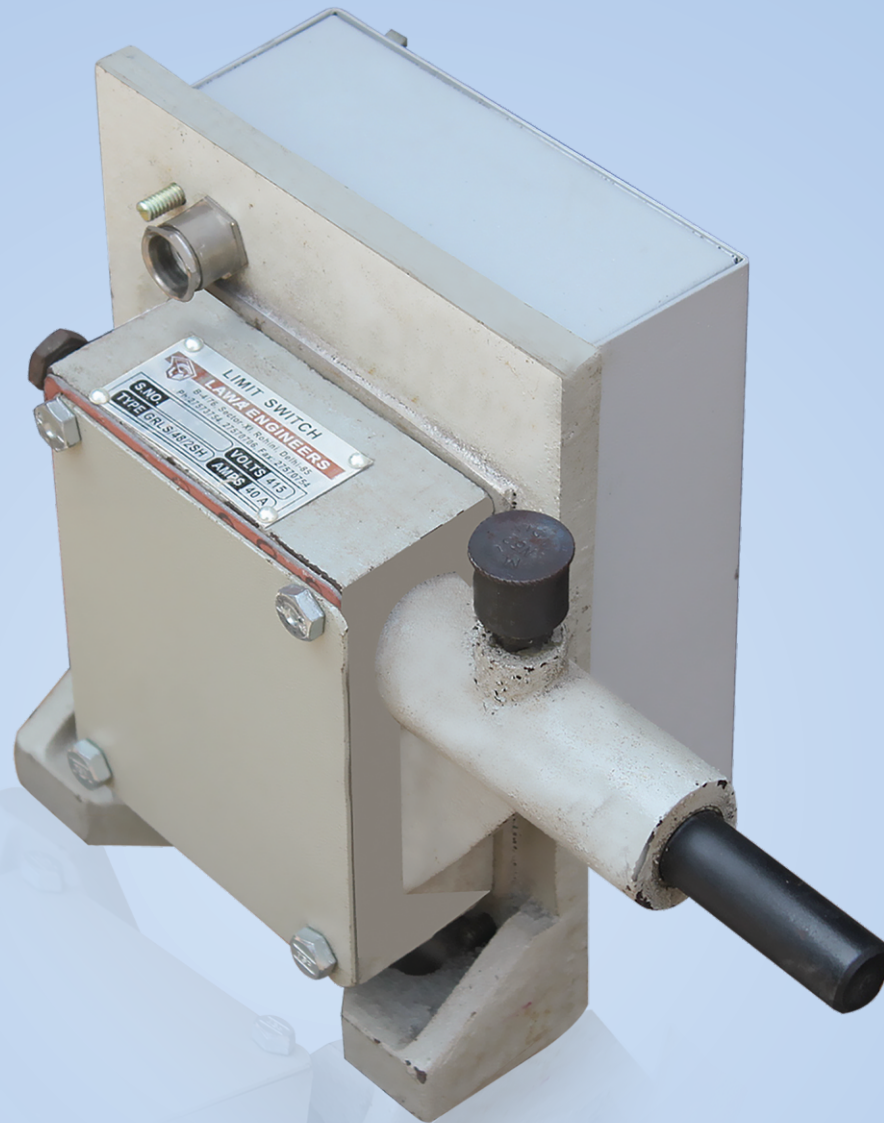

ROTARY GEARED LIMIT SWITCHES (MODEL GRLS)

Introduction

Lawatherm Rotary Geared Limit Switch GRLS is used to trip supply when the moving loads reach the extreme end positions of working zone.

Operation

A two (or more) Contact Elements are operated by respective rotating Cams, suitably adjusted on a Cam Shaft which rotates with fixed speed ratio of the drive motor shaft. The cams can be suitably positioned so that they trip motor supply and stop the motion at the required point of travel.

Application

Rotary Geared Limit Switches are suitable for use on reversing drives such as Hoists, Winches, Rolling Mills and various other mechanisms used in Steel Plants such as Coke Oven, Feeding machinery etc.

Body Material	MS Sheet (Powder Coated)
Protection Degree	IP-41 Confirming to IS-13947(PART)-1)1993
Gear Ratio	48 : 1 60 : 1 96:1
Drive	Worm Drive
Cable Entries	2 X 3/4" Conduit
Contact Material	Silver Cadmium
Rated Voltage Insulation	500 V.a.c.
Thermal Test Current	10 Amps. / 40 Amps.
No. Of Contact	2 Nc Or 4 Nc
Cam Setting	Adjustable

Rotation Rotations	Effective Rotation	Useful Model	2 Contacts Model	Contacts
48:1	42	40	GRLS/48/2SH	GRLS/48/4SH
60:1	52	50	GRLS/60/2SH	GRLS/60/2SH
96:1	84	80	GRLS/96/2SH	GRLS/96/4SH

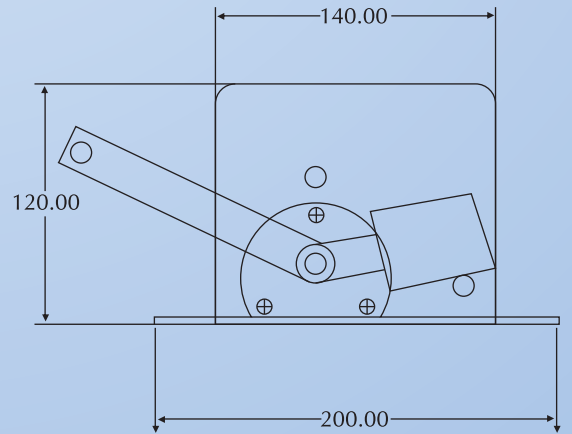
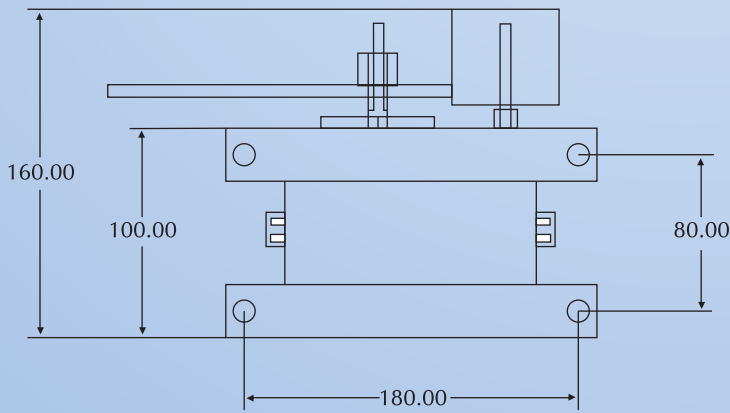
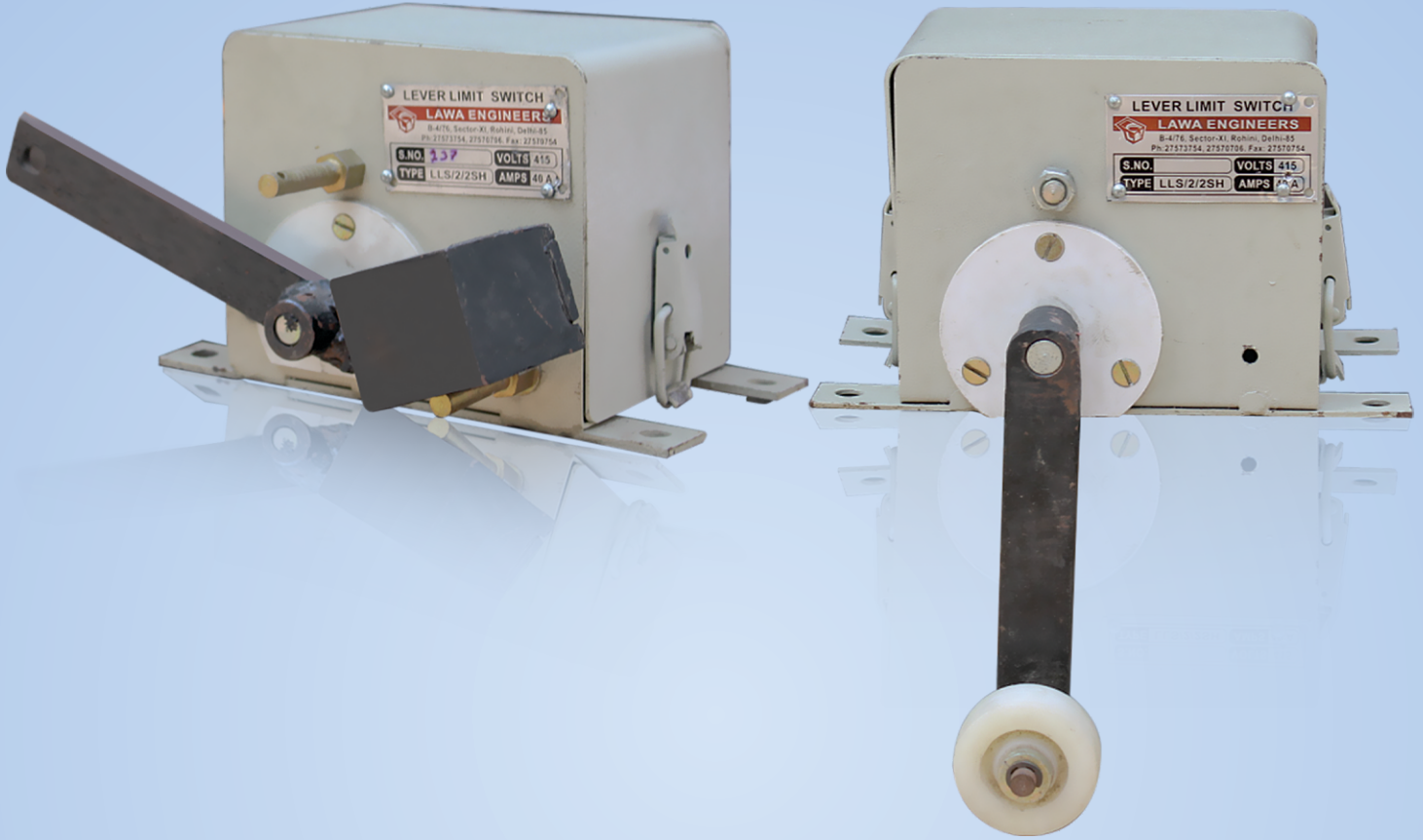

LEVER/COUNTER WEIGHT OPERATED LIMIT SWITCHES

Introduction

Lawatherm Lever (and weight operated) type Limit Switch LLS / CWLS operates the control change-over Contacts of motor of an moving equipment when a Cam moving with loads actuates the Lever of limit switch. This turns the cams on a square shaft and operates the NO / NC contact elements.

Operation

Two or more Contact Elements are operated by respective rotating Cams, which are suitably fixed on a square Cam Shaft turned by a lever or weight. The contacts operate at 14 from central neutral position.

Design

The Sheet Steel body, Lever and Cover of the Limit Switch are finished by powder coating treatment. The Cam Shaft is mounted in the housing on moulded Nylon bushes (bearing) and are fixed through the front & rear walls.

Technical Data :

Body material	Powder coated sheet
Degree of protection	IP- 41
Mounting position	Floor mounting
Cable entries	Twin. 3/4' BS conduit
No. of contact	2 / 3 /or 4
Wire connection	Silver-cadmimum
Rated voltage	500 V ac
Thermal test current	10 A

Operating Executions :

The operating mechanism can be offered in two executions:

1. Roller Operating A Lever :

These Limit Switches are used for E.O.T. Cranes, Wagon Shunting devices, Elevators, Travel mechanism or such linearly moving mechanisms to prevent over-travel. The position of operating lever is in up / down, and can be changed in steps of 90 at site.

2. Lever Actuated By A Dead Weight :

These Limit Switches are used to prevent over hoist motion with weight. Counter weight is provided in this case. The same is lifted with wire rope to prevent over hoist position.



FLEXIBLE GEARED COUPLINGS

The Lawatherm Flexible Geared Couplings are suitable for over coming the following type of misalignments.

Parallel Offset: Where axis of connected shafts are parallel but not within the same straight line.

Angular: Axes of shafts intersect at the center of coupling.



Combined Angular: Offset axes of shafts are neither parallel nor do they intersect.

Hubs of Lawatherm make Couplings are machined from EN-9 Steel forgings to close tolerances for accurate alignments and proper balance.

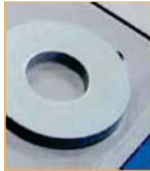

LIFTING MAGNET

Lawatherm is known for providing most appropriate magnetic material handling insulation spare solutions to various industry segments. We specialize in magnet systems for the scrap, steel and railroad industries. What has made us successful is our service to the customer and the well thought out design and quality of our systems. You demand maximum performance, durability and long life. We'll keep you up and running! Whether you are new to magnet systems or a long time user, Lawa is here for you! Experience counts and we've got it! Take a look at what we have to offer and give us a call. We'll set you up with what's right for you. We are your magnetic material handling specialists!

Application	Conductor Insulation	Deck Separator	Core Insulation	Coil leads
Product	PSA Mica Tape 	Mica Washer 	Mica Paper 	Mica Sheet 
Composition	silicone bonded glass-backed mica taps	machined, thick mica plate in micapaper or micapaper or flake	micapaper glass backed or without backing	silicone bonded mica flake flexible
Properties	high temperature resin rich, highly flexible tape which huges the conductor	low thermal conductivity prevent heat build-up in coll; compressive strength	heat barrier	highly stable at high voltages

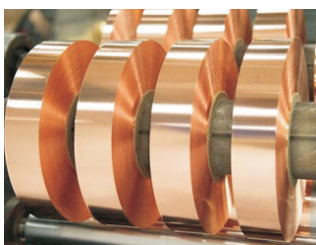

Coil Core (copper/aluminium)
LAWATHERM using of Copper/Aluminium strips are highest grade of copper/aluminium that is sourced from the reliable and trusted mfg co

Dimension Details:-	Thickness: 1mm (min)-10mm Width: 1mm-20mm
Conductivity :-	Above 97% IACS min in Half Hard Above 99.95% in annealed
Purity :-	Copper/aluminium - 99%
Specifications (OFC):-	Copper/aluminium : 99.99%, O2: <10ppm Copper/aluminium : 99.95%, O2: <10ppm
Supply Condition:-	coils

Lifting Magnet Repair

Lawatherm does Lifting Magnet Division repair & rewinding of lifting magnets of both copper & aluminium of all brands as well as the manufacturing of new. We understand the importance of getting your magnet back up and running in optimal condition in order to minimize downtime. We offer exceptional repair services for all brands magnets.

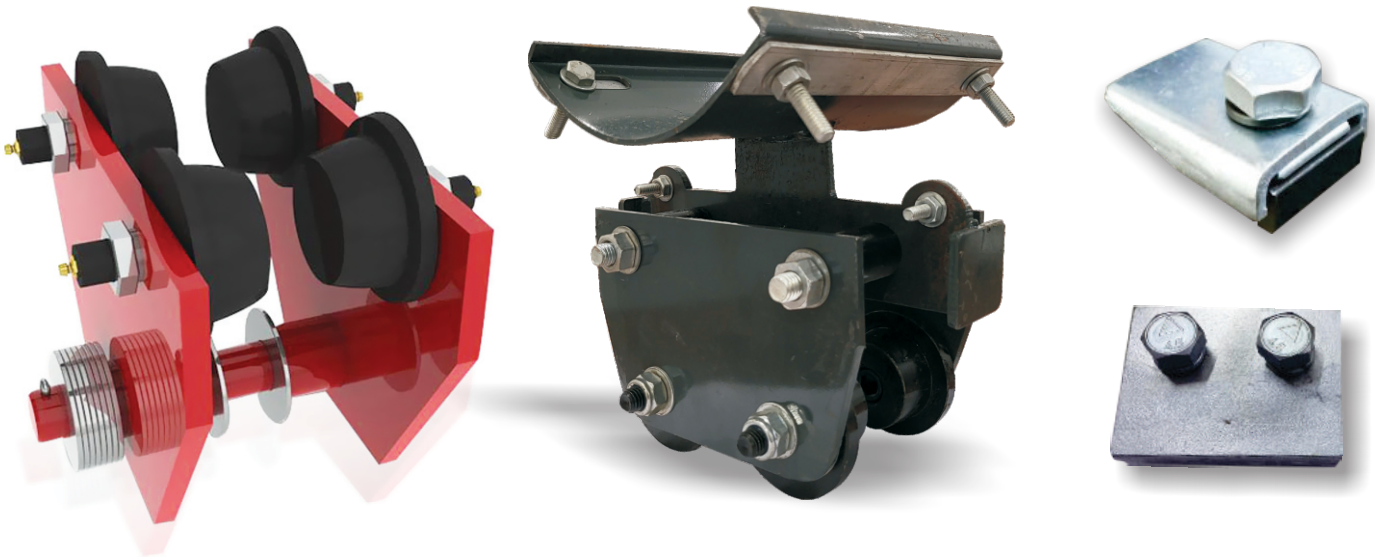

CABLE TROLLEY & CLAMP

Lawatherm hoist trolleys provide the connection between the lifting device and the bridge. The trolleys are designed for effortless movement along the bridge.

The stamped body fits most rigid hook or eye lifting device. Festoon clamps anchor the festooning at the start of the runway and bridge. Festoon trolley is used to support flat cable or air hose along the runway or bridge. The trolleys have four wheels and a pivoting festoon saddle support. They are ideally suited for long runways or with round cable or air hose..



SYSTEMSPRING OPERATED CRD

Lawatherm make spring operated cable reeling drums are powered with springs and has an automatic rewind feature which provides an extremely simple way of supplying power to machines such as cranes and hoists. These spring cable reeling drums are used for both AC and DC applications. These reels recovers and store the cable in multiple layers on the drum.

Standard reels are supplied for the cable fed in the clockwise direction, when viewed from the slipping side. The same can be provided for anticlockwise feed of cable also. These reels are extremely simple to mount, and can be mounted on the structure with the help of a supporting flange - If no suitable structure is available, then Vibrator Motor (Unbalanced) can be connected to the flange and this can be fixed to the floor or tray etc.

The springs used in these reels are manufactured from the highest quality materials and are of clock spring type. A wide range of characteristics can be obtained by assembling these springs singly or in series or in parallel.



CONTINUOUS CASTING MACHINE

Continuous casting machine is used for slabs, square billet, round billet, H-beam and relative spare parts. The mould parts of Continuous Casting Machine are adopted from Germany. The technology used for Continuous Casting Machine is introduced in Germany.

CONTINUOUS CASTING MACHINE SPARE (CCM)

The continuous casting of molten steel into billets, blooms and slab products, has been highly refined over the years into an extremely sophisticated system. The continuous casting process is expected to produce metallurgically sound products at the lower possible cost, and this is being achieved in many steelworks throughout the world.

Lawatherm specializes in after market and genuine spare parts for continuous casting machine. We are one of the largest and truly independent suppliers of the major OEM's and aftermarket spare parts and service for Consact India, Siemens and others. In addition Lawatherm is committed to provide the largest selection of spare parts in the industries. We also offer a broad range of high quality genuine spare which come with same as their branded counterparts, together with complementary accessories. We are continuously increasing our inventory to meet the demands of our customers. All spare parts whether genuine or equivalent are fully compatible. As a leading Indian steel industries with the largest service network and a complete range of concast spare.

1. Copper mould tube (square, rectangle and round)
2. Crystallizing equipment of continuous casters
3. Mould cooling jacket
4. Spray nozzle
5. Primary cooling hose
6. Slide gate valve
7. Heat expansion compensator Disc Springs Eye Bolt

QC Slide Gate System Make Lawatherm
1. Adaptor Frame
2. Housing
3. Fixed Plate Holder
4. Slider
5. Nozzle Holder
6. Housing Cover
7. Cylinder Bracket
8. Extension Rod
9. Eccentric Clamping Device
10. Expansion Compensating Nut
11. Eye bolts
12. Gliders
13. Gliding Rails
14. Guide Bush
15. Key for adaptor frame
16. Hinge Pin
17. Centering Ring
18. Fixed Plate
19. Sliding Plate
20. Exchange Collector Nozzle

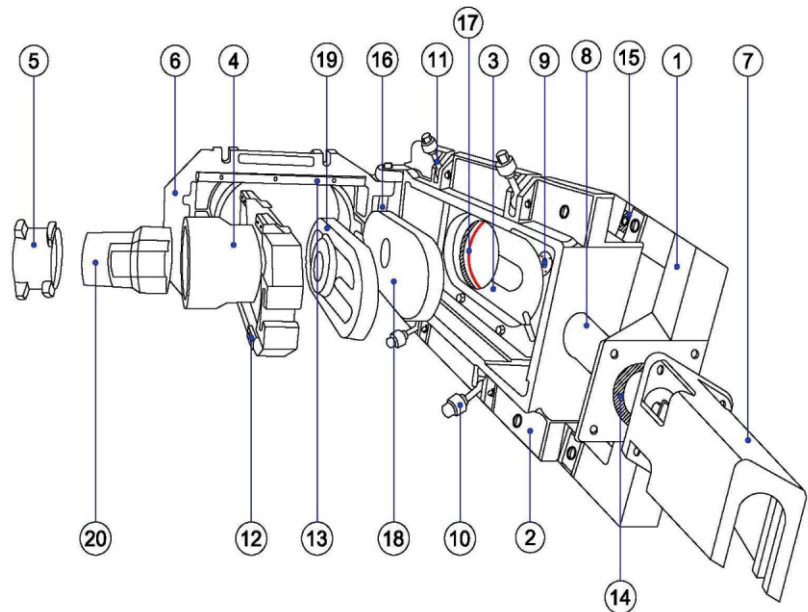

The right spare parts must always be available so that production standstills are kept short. At the same time, capital tie-up and storage costs have to be kept low. Lawatherm supplies wear and spare parts quickly and reliably for all production stages, and supports the customers.

Ladle Slide Gate System



Hydraulic Cylinder for Slide Gate Laddle



Mechanically Operated Slide Gate System



The Manual Slide Gate System is ideally designed for Ladle Sizes up to 10 Tons used in foundries as well as Steel Plants. The System allows easy Operation with the help of a long Lever giving tremendous mechanical advantage. The Curvilinear Motion is specially designed for Operation of the Lever reducing both the force to be applied as well as the Refractory Cost. The Manual Slide Gate System is designed for multiple openings required for foundry applications as well as pit-side applications in the Ingots Casting Plants. This system can also be used for Continuous Casting Application where constant throughput is required through out the casting period. Both the above applications are easily executed by choosing proper Refractory's and by using appropriate Slide Gate Operation Technique. Manual Slide Gate System has very few components, which can be easily assembled and dismantled. Jigs and Fixtures are eliminated thus avoiding the preparation time. Since no Hydraulic Operations are required both the Capital Cost as well as Running Costs are substantially reduced. Manual Slide Gate System is an ideal solution for small Steel Plants and the Foundries looking for inexpensive solutions for controlling the Flow of Liquid Steel. All parts are available Ex-Stock and Performance is Guaranteed backed by extensive service.

Hydraulic Operated Slide Gate System

The Slide gate system is a prerequisite for Modern day refining and casting practices wherein temperatures normally shoot up suddenly and violent reactions take place within the ladle. A Slide Gate System for Bottom pouring ladles has inherent advantages over the conventional Stopper Road System. Benefits can be simply stated as lesser turnaround time, therefore lesser ladles, Higher temperatures of molten metal and longer casting times. lawatherm has been in the field of Slide Gates for several years now. We have rendered invaluable service to steel plants by way of solving problems and developing quality spare parts and systems, adapted to local conditions at affordable prices. Thus we are in a position to for see any problems in an existing system and suggest solutions for the same. Our constant striving to upgrade Systems and Services has ensured a quality product with numerous inherent advantages over products / systems based on Western Technology as well as tiny manual systems.

Indegenious

The lawatherm Slide Gate System is totally indigenious. A system suited to local conditions with robust components for rough handling and tough steel plant conditions.



Flow Full Cone Nozzles

Full Cone Nozzles has high precision & uniform liquid distribution circular area. This gives uniform liquid distribution throughout the entire circular impact area. This gives uniform liquid distribution throughout the entire circular impact area. The basic design of this nozzle is based on fundamental principal of axial swirling motion

Lawatherm Spraying nozzles also has another variety of full cone nozzles which is called Spiral Full Cone Nozzle. There is not any insert which gives clogging free nozzle & spiral impact throughout the entire circular area.

FULL CONE NOZZLE SPRAY CHARACTERISTICS

Application:

- Produces a full cone pattern
- Sprayed volume is evenly distributed across spray pattern
- Available with a range of spray angle

Materials and Construction

- Standard materials are Brass and Stainless Steel
- Male and female thread available
- 3/8" or 1/4" BSP / NPT threaded connections available
- Specially designed internal core ensures a good resistance to clogging
- Standard spray angle 45°, 65°, 80°, 90°, and other spray angle on request.

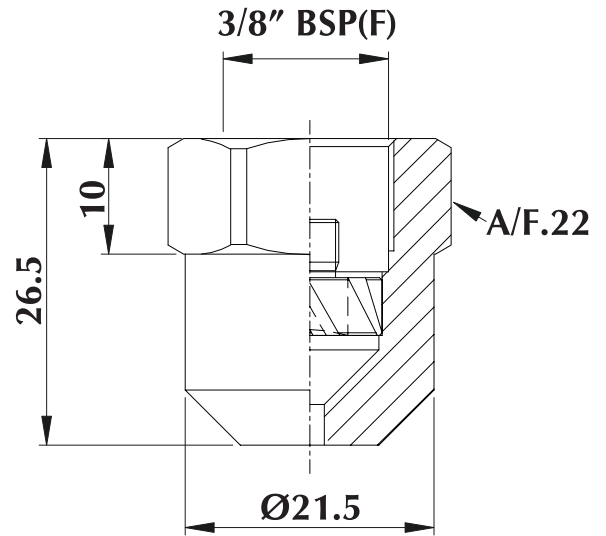

Flow Rate (l/min) @ Different Pressure Value (Bar)									
Sr. No.	Model No.	Angle	1.0 Bar	2.0 Bar	2.8 Bar	4.0 Bar	5.0 Bar	6.0 Bar	7.0 Bar
1	1565	65°	0.90	1.25	1.50	1.80	2.00	2.20	2.35
2	2065	65°	1.20	1.70	2.00	2.40	2.70	2.90	3.15
3	2465	65°	1.40	2.00	2.40	2.80	3.20	3.50	3.80
4	2565	65°	1.49	2.11	2.50	2.98	3.34	3.65	3.95
5	3065	65°	1.80	2.50	3.00	3.60	4.00	4.40	4.75
6	3565	65°	2.10	2.95	3.50	4.20	4.70	5.10	5.55
7	4065	65°	2.40	3.40	4.00	4.80	5.30	5.85	6.30
8	4565	65°	2.69	3.80	4.50	5.38	6.01	6.59	7.12
9	5065	65°	3.00	4.20	5.00	6.00	6.70	7.30	7.90
10	5565	65°	3.28	4.64	5.50	6.57	7.34	8.05	8.69
11	5965	65°	3.50	5.00	5.90	7.00	7.90	8.60	9.30
12	6065	65°	3.60	5.10	6.00	7.20	8.00	8.80	9.50
13	7065	65°	4.20	5.90	7.00	8.35	9.35	10.25	11.05
14	7565	65°	4.50	6.35	7.50	8.95	10.00	10.95	11.85
15	8065	65°	4.80	6.80	8.00	9.60	10.70	11.70	12.65
16	9065	65°	5.40	7.60	9.00	10.75	12.00	13.15	14.25
17	10065	65°	6.00	8.45	10.00	11.95	13.40	14.60	15.80
18	12065	65°	7.20	10.10	12.00	14.30	16.00	17.60	18.95
19	13065	65°	7.77	10.99	13.00	15.54	17.37	19.03	20.55
20	15065	65°	8.96	12.68	15.00	17.93	20.04	22.96	23.75
21	16065	65°	9.55	13.50	16.00	19.10	21.40	23.40	25.30

These part numbers are easy to use and identify, example:

Brass or Stainless steel 3/8" Female - 2045 / 2065 = 2.00 litre/min @ 2.8 bar with a 45 & 65 angle



Lawatherm Flat Jet Nozzles ensures uniform, parabolic distribution of liquid. This flow geometry of nozzle produces compact and accurate jets with stable spray angle. These nozzles are suited for all universal application. These nozzles are not easily affected by pressure fluctuation. These nozzles are not prone to clogging.

Lawatherm Flat jet nozzles has simple and cost saving fixing attachments such as Easy Dovetail Guides.

Lawatherm Flat jet Nozzles are available with many flow rate sizes, Flat jet width, jet depth & also various spray angles to suit for various application

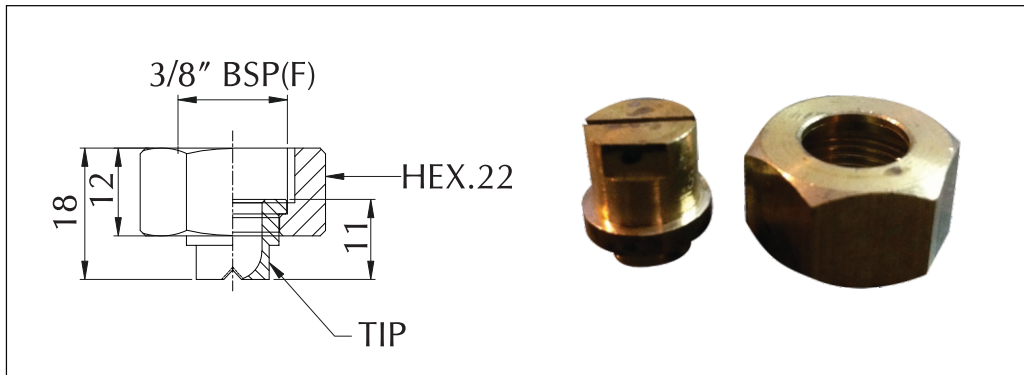

Flat nozzle tips are usually mounted onto a pipe using a welded 3/8" nipple or a clamp and secured in place with a retaining nut. The precision machined orifices can be protected against the risk of clogging by using a filter which fits neatly into the nipples and clamps, specifically designed for this purpose.

Flow Rate (l/min) @ Different Pressure Value Bar									
Sr. No.	Model No.	Angle	1.0 Bar	2.0 Bar	2.8 Bar	4.0 Bar	5.0 Bar	6.0 Bar	7.0 Bar
1	2065	65°	1.20	1.70	2.00	2.40	2.70	2.90	3.15
2	2565	65°	1.49	2.11	2.50	2.98	3.34	3.65	3.95
3	3065	65°	1.80	2.50	3.00	3.60	4.00	4.40	4.75
4	3565	65°	2.10	2.95	3.50	4.20	4.70	5.10	5.55
5	4065	65°	2.40	3.40	4.00	4.80	5.30	5.85	6.30
6	5065	65°	3.00	4.20	5.00	6.00	6.70	7.30	7.90
7	5765	65°	3.28	4.64	5.70	6.57	7.34	8.05	8.69
6	6065	65°	3.60	5.10	6.00	7.20	8.00	8.80	9.50
7	8065	65°	4.80	6.80	8.00	9.60	10.70	11.70	12.65

These part numbers are easy to use and identify, example:

Brass or Stainless steel 3/8" Female -2065 = 2.00 litre/min @ 2.8 bar with a 65° angle

Heat Expansion compensator assembly

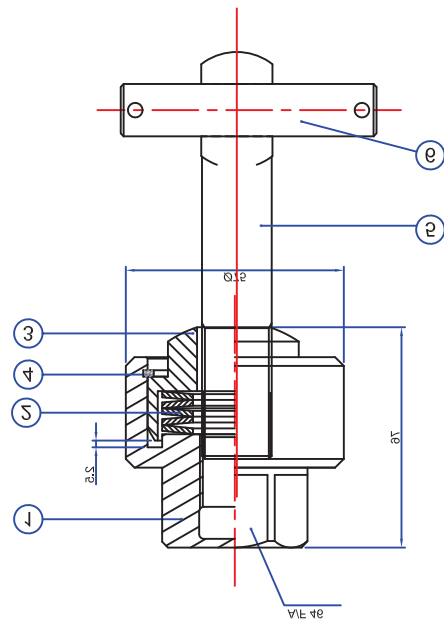

Heat expansion compensator assembly for slide gate system type 1QC / 2QC / 3QC / 4QC		
Sr. No.	Description	Quantity
1.	Heat expansion compensating nut	1 Nos.
2.	Disc Springs	1 Nos.
3.	Trust Pad	1 Nos.
4.	Internal circlip - 60 x 2	1 Nos.
5.	Eye Bolt	1 Nos.
6.	Pin for Eye Bolt	1 Nos.

Heat expansion compensator Disc Springs Eye Bolt are subdivided according to the different material, which are applicable to ultra-high temperature environment (up to 500°C), they are widely used in Heat Exchangers, Boilers, Furnaces & Ovens, Chemical Processing, etc



Dummy Bar Pin Bolt Bush

We manufacture Dummy Bar with gun metal bushes. Dummy Bar is used to transfer the necessary pulling force to the slab, poured in the open when the seal from the mold following. And rely on the straightening machine will be cooled by the mold leads to the casting mold by the secondary cooling zone to enable the straightening machine to the continuous casting billet to the direction of the conveyor; Dummy Bar head from Dummy, and dummy transitional shaft is composed of three parts.



Cylinder & Seal

Lawatherm is one of the renowned suppliers of Hydraulic & Pneumatic Spares. We Provide Hydraulic Pump, Valve, Seal, Pipe, Cylinders, Power Pack, Automation Equipment and SPM. Lawatherm holds in-depth stocks of a wide range of Hydraulic products including some of the best brands i.e. Dowty, Yuken, Polyhydron, Jacktech, Suprimo, Rexroth, Vickers, Bosch are available with us in ready stock. We will give you the import substitute also in very competitive price. We have a wide variety of Hydraulic Equipment, which have become benchmarks in the industry. Our quality controllers strictly check the range as per the standard quality parameters. We want to make sure that we can offer our clients highly efficient and durable range of hydraulic spares.

Application

- Entry
- Dummy bar receiver (DBR)
- Pusher
- Retractable dummy bar guid(RDBG)
- Exit
- Slide gate laddle

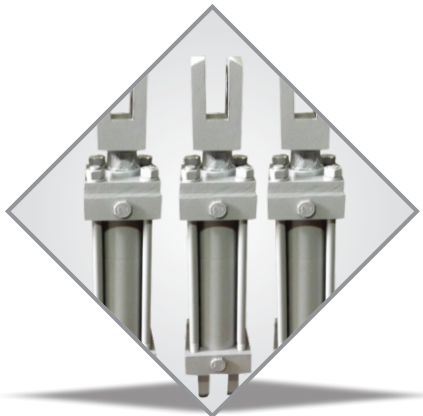

Rubber O-Rings Silicone

Silicone possess excellent resistance to temperature extremes. Silicone's retention of properties at high temperatures is superior to other elastic materials. Silicone has poor tensile strength, tear resistance and abrasion resistance.

Lawatherm are the largest on-line distributor of O-rings in the india .In addition to O-rings in NBR and Viton sold online we are able to supply o rings in many other sizes and polymers including Silicone, EPDM, KALREZ®/FFKM on a short lead time.

We can usually supply many other non standard polymers like HNBR, PTFE, XNBR, PU, CR; hardness (40 to 90 ShA) and colours (blue, brown, grey, red, white, yellow, green) in about 4 working weeks (subject to minimum order charge)

Temperature Range

- Up to 200°C (Intermittant)
- Down to -60°C

Chemical resistance

- Dry heat
- High - aniline point oils
- Chlorinated DI - phenyls
- Food processing applications
- Excellent ozone resistance.
- Water (Low temperature only)



Switch Mode Power Supply (SMPS)

A switched-mode power supply (switching-mode power supply, SMPS, or switcher) is an electronic power supply that incorporates a switching regulator to convert electrical power efficiently. Like other power supplies, an SMPS transfers power from a source, like mains power, to a load, such as a personal computer, while converting voltage and current characteristics. Unlike a linear power supply, the pass transistor of a switching-mode supply continually switches between low-dissipation, full-on and full-off states, and spends very little time in the high dissipation transitions, which minimizes wasted energy. Ideally, a switched-mode power supply dissipates no power. Voltage regulation is achieved by varying the ratio of on-to-off time. In contrast, a linear power supply regulates the output voltage by continually dissipating power in the pass transistor. This higher power conversion efficiency is an important advantage of a switched-mode power supply. Switched-mode power supplies may also be substantially smaller and lighter than a linear supply due to the smaller transformer size and weight.

S8JC-ZS, newly released Power Supply with CE marking, additional models for economical Power Supply. S8JC-Z series.

S8JC-Z/SBJC-ZS is our best standard power supply for

- Material cost reduction
- Export machines, required safety standard
- Time saving for installation by DIN-rail mounting



Quick release couplings



High-quality quick-action coupling made of steel, stainless steel, brass or plastic for practically every application contingency

Very robust, rapid and secure coupling of practically all fluid media. Special solutions for your application needs can also be implemented upon request.

Variants:

- flat-sealing (leakage-free), cone-sealing or ball-sealing
 - with or without check valve
 - Plug-in or screw coupling
 - Bulkhead, pipe, hose or block integration
 - optional with dust cap, dust plug
 - optional with additional pressure relief (coupling under residual pressure)
- Materials available for shipment:

- Galvanised steel / zinc-nickel
- Stainless steel 1.4571
- Brass
- Plastic

Air Spring Bellow



- > Ø 6 ... 26 inch (152 ... 660 mm)
- > Almost frictionless operation
- > No maintenance or lubrication
- > High isolation level for vibration applications
- > Very easy to install – no alignment problems

- > Typical applications; actuator, air spring, or vibration isolation



Technical features

Compressed air lubricated or unlubricated, Nitrogen, water (with glycol)
 Operation:
 Single acting
 Operating pressure:
 5,5 bar (79 psi) recommended
 dynamic pressure
 8 bar (116 psi) maximum

Nominal diameters:
 6, 8, 10, 12, 14 1/2, 16, 21, 26 inches
 Strokes:
 From 55 ... 430 mm max., depending on diameters and number of convolutions

Operating temperature:
 for M/31000 (Standard)
 -30° ... +50°C (-22° ... +122°F)
 -40° ... +70°C (-40° ... +158°F) □
 IR for TM/31000
 -20° ... +70°C (-4° ... 158°F)
 -25° ... +90°C (-13° ... 194°F) □
 ECO for EM/31000
 +50° ... +115°C (+122° ... 239°F)
 -20° ... +130°C (-4° ... +266°F) □
 □ The number represent the maximum permissible operating temperature. It is sutibel to operated with restriction at this temperature, the air bellow may have a reduced life time!

Materials:
 End plates: steel, chromplated
 Studs: steel, zinc plated
 Central ring: aluminium or steel, chromplated, partly moulded in
 Bellow: M/31000, M/32000: NR/BR, SBR compound rubber
 TM/31000, TM/32000: IR
 EM/31000, EM/32000: ECO

Rubber Bellow Expansion Joint

Our domain expertise has enabled us to come up with an excellent collection of Rubber Bellow Expansion Bellow. All the offered bellows are designed in accordance with international quality standards, using quality stainless steel material and the latest technology. Our bellows can also be customized as per the specifications laid down by the patrons.

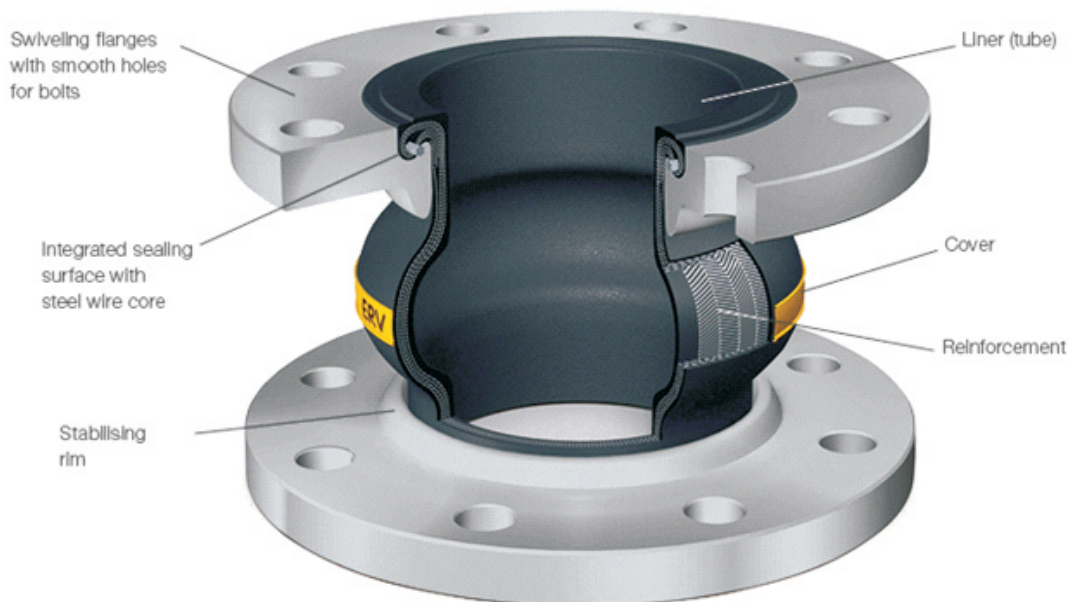

Accessories

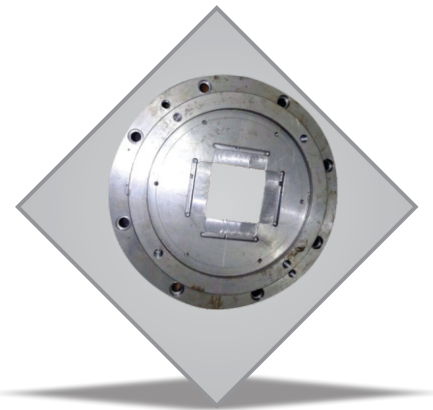
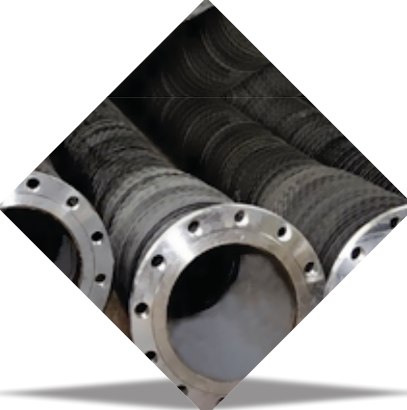
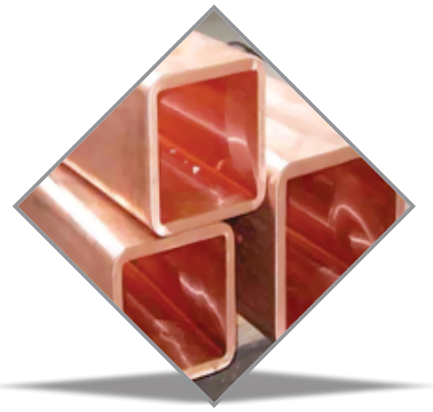
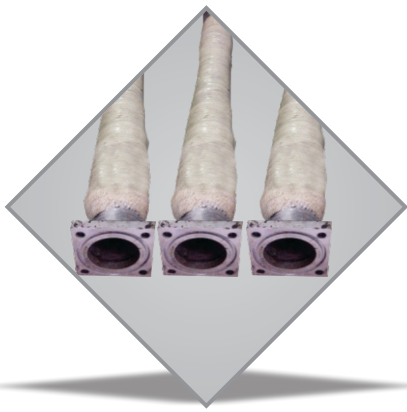
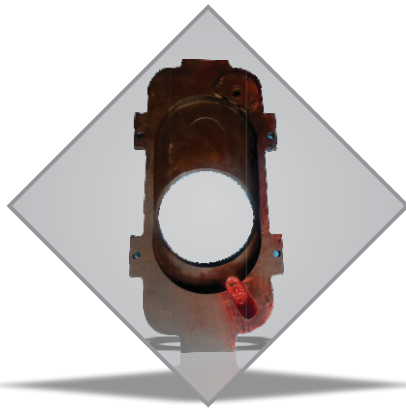
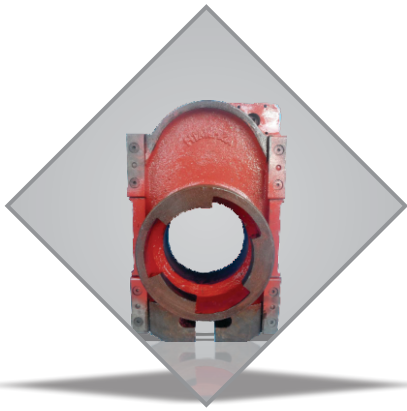

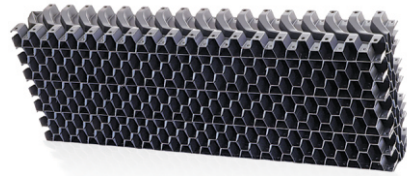

COOLING TOWER SPARES

Cooling Tower can be used to reject heat from various sources such as machinery or heated process material. The primary use of large, industrial cooling towers is to remove the heat absorbed in the circulating cooling water systems used in power plants, petroleum refineries, petrochemical plants, natural gas processing plants, food processing plants, semiconductor plants, crop drying, mines, foundries, steel plant, rolling mill, glass plant, power plant and other industrial facilities.

Water Softening Product



WATER SOFTENING PLANT SPARES

Water Softeners that are effective in reducing the hardness of the water. They help in producing zero soft water by highly acidic cation exchanger, which removes calcium and magnesium ions from the water. We design a series of softeners that have counter current regeneration with up flow rate and concurrent regeneration with down flow rate. These are capable of operating for longer periods at low costs and are suitable for medium scale industries, Steel plant and other commercial industries.



Lawatherm Furnace Pvt. Ltd.

Corporate Office:

N-1/10, Sector-5, DSIIIDC, Industrial Area Bawana, Delhi-110 039

Ph : +91-11-4309 3754, 4509 3754, 4353 4754, 2757 3754

Mob : +91-98102 93754, 98102 43754

E-mail : lawatherm@gmail.com

UNIT- I

N-1/30, Sector-5, DSIIIDC, Industrial Area Bawana, Delhi-110 039

UNIT- II

Plot No-164, V&PO. Punjab Khore, Delhi - 110 081

